



woodworkers HARDWARE catalogue

0824

woodworkers.com.au



ABN 84 010 877 675

sales@woodworkers.com.au

BRISBANE
1095 Ipswich Rd
Moorooka 4105
☎ 07 3848 1383
F: 07 3892 1476

GOLD COAST
Warehouse Road
Southport 4215
☎ 07 5571 0088
F: 07 5571 0617

SUNCOAST
53 Wises Road
Maroochydore
☎ 07 5479 0999
F: 07 5479 0911

SYDNEY
2 Sydenham Rd
Brookvale 2100
☎ 02 9938 4999
F: 02 9938 4666

All products subject to change after publication. Refer to our website www.woodworkers.com.au for current costings. All material copyrighted. Artwork in this catalogue may have been digitally altered and the actual product or colours may differ slightly.



antique raj
handle



timber door + window hardware specialists

Woodworkers designs and imports its own branded hardware specifically suited to solid timber joinery applications. We also source selected hardware items domestically where available to offer our customers the widest range of options specific to door and window applications. Because there is no middleman in the majority of hardware we offer, we can invest in premium finishes and materials. Our PVD finishes, for example, never tarnish and much of our stock is built around a stainless steel core instead of brass or diecast zinc for more durable long term performance. Our black hardware range is the largest available anywhere in Australia. Most importantly however, the hardware range we offer is tried and tested over many years to perform on timber joinery.





PART 1

presentation pull handles

Woodworkers presentation door handle range is the largest and most innovative in Australia. We design and import products that we hope will stimulate your imagination. We continue to offer the widest range of materials and finishes that complement our industry leading range of fine timber doors to enable you to make your entrance highly individual.

LEGEND

- | | |
|----------------------|--------------------|
| ■ silver finishes | ■ timber finishes |
| ■ gold finishes | ■ antique finishes |
| ■ black finishes | ■ copper alloys |
| ■ white finishes | ■ polymer+plastic |
| ⊗ off-white finishes | ⊗ brown finishes |

refer pricelist for actual materials and specifications

SATIN SILVER HANDLES

The Helio Range

- 3052S 1500mm back to back set only
- 3049S 1200mm back to back set only
- 3045S 900mm back to back set only
- 3039S 450mm

also available

- 3054S 1800mm back to back set only
- 3056S 2000mm back to back set only



See our Helio Discounted Bundle Buy details on pg 17

Helio handles also available in 316 marine grade SS

- 3041S 450mm
- 3043S 600mm
- 3047S 900mm

WHAT'S THE DIFFERENCE BETWEEN 304 STAINLESS STEEL AND 316 MARINE GRADE?

316 Marine Grade has higher chromium content making it more resistant to discolouration. However all stainless steel can develop tea stain unless cleaned and waxed regularly. See FAQ 9 on our website for more information.

- 3023S 1200mm back to back set only



Helio

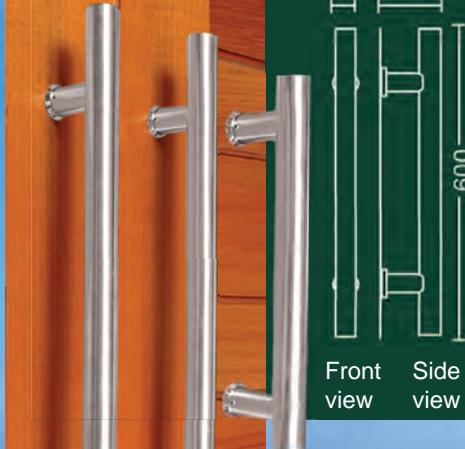

Front view Side view

- 3037S 300mm

- 3042S 600mm

Offset Helio

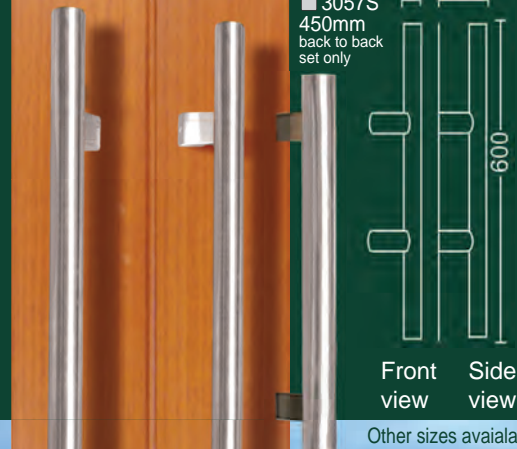

Front view Side view

- 3057S 450mm back to back set only

- 3059S 600mm back to back set only

Other sizes available

- 3061S 900mm back to back set only
- 3063S 1200mm back to back set only
- 3065S 1500mm back to back set only
- also available in 316 marine grade SS
- 3058S 450mm back to back set only
- 3060S 600mm back to back set only
- 3062S 900mm back to back set only

Domino

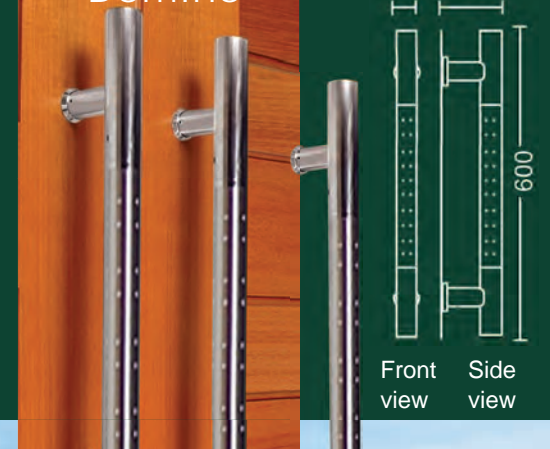

Front view Side view

- 3034S 450mm

- 3035S 600mm

silver is uniquely contemporary...



- 3021S 410mm back to back set only

- 3022S 560mm back to back set only



Front view Side view

Cirque

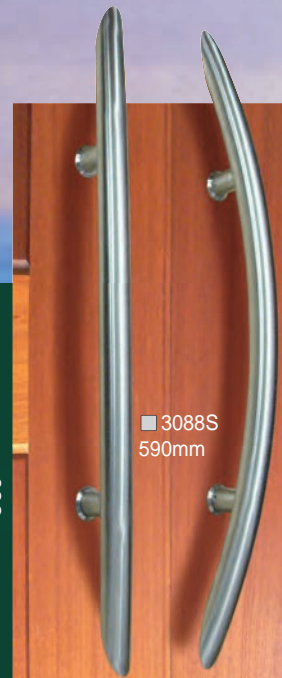

- 3088S 590mm



Front view Side view

Offset Nova

- 3019S 600mm back to back set only

Cavus handles only available in 316 marine grade SS

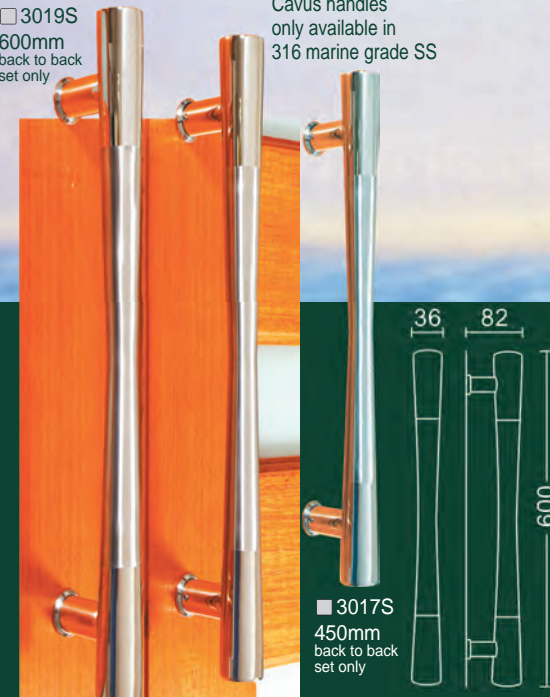

Front view Side view

Cavus

- 3017S 450mm back to back set only

Sceptre



also available in 304 Stainless steel while stocks last

- 3096S 450mm

- 3097S 450mm back to back set only

316 marine grade SS

- 3080S 600mm

also available

- 3083S 1000mm back to back set only

also available in 316 marine grade SS

- 3079S 300mm
- 3082S 600mm

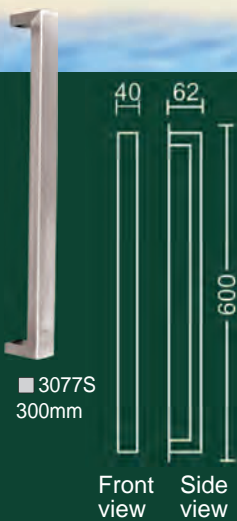

- 3077S 300mm

Neo

Olympus



- 3090S 530mm

see our roller locks selection suitable for use with presentation pull handles.

Amman



- 3002S/R 520mm right handed
- 3002S/L 520mm left handed

- 3001S/R 315mm right handed
- 3001S/L 315mm left handed

Aqua Jazz

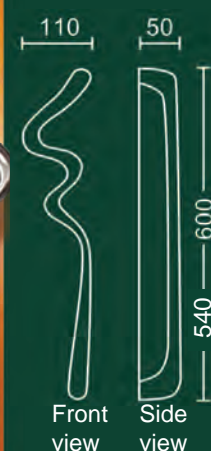
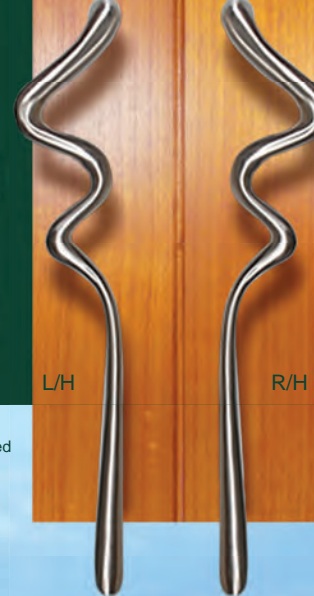

- 3006S/R 540mm right handed back to back set only
- 3006S/L 540mm left handed back to back set only



- 3086ST 800mm back to back set only

- 3084ST 600mm



Timber Neo



- 3012S 800mm back to back set only while stocks last

- 3015ST 800mm back to back set only while stocks last

also available in 316 marine grade SS

- 3011S 600mm back to back set only
- 3013S 800mm back to back set only

- 3010S 600mm back to back set only while stocks last



Carillion



- 3010S 600mm back to back set only while stocks last



Timber Carillion

Swerve II

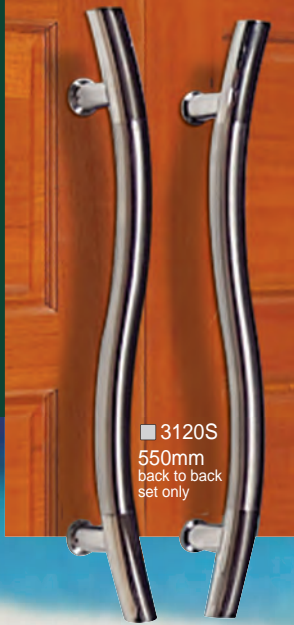

■ 3120S
550mm
back to back
set only



Front view
Side view

curves may vary
between production batches

Crescent



■ 3033S
600mm



Front view
Side view

■ 3032S
450mm
also available
■ 3031S
300mm
while stock
lasts

Granada

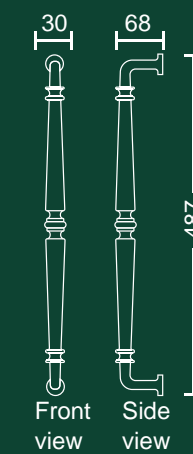

Front view
Side view

■ 3146S
487mm

Granada on Plate

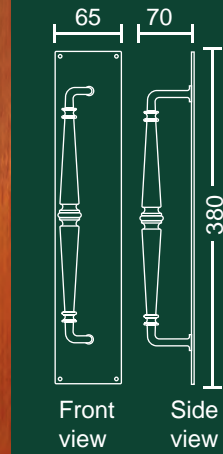

Front view
Side view

■ 3147S
380mm

see our roller locks selection
suitable for use with
presentation pull handles.

□ 3108SXB
600mm
back to back
set only

□ 3108SXR
600mm
back to back
set only

□ 3108SXGr
600mm
back to back
set only

□ ■ 3113ST
600mm
back to back
set only



Black
Pearl

Red
Granite

Green
Onyx

Skittle



Timber Skittle



□ ■ 3111ST
450mm
back to back
set only



Front view
Side view



■ 3106S
600mm

Skittle

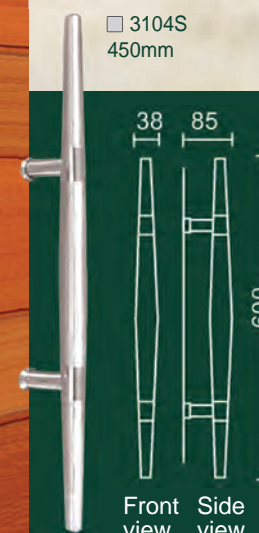

□ 3104S
450mm

Front view
Side view



□ 3144S
755mm

Czar Silver

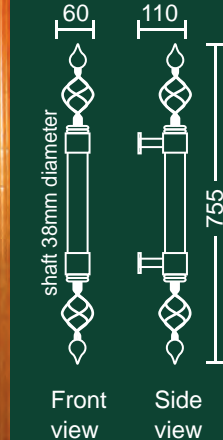

Front view
Side view

Finesse

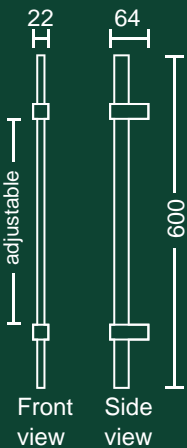

■ 3036S
600mm
back to back set only
adjustable

Sizzle



■ 3102S/L
545mm

■ 3102S/R
545mm



□ 3151S
645mm (width 40mm)
back to back set only
also available
□ 3150S
450mm (width 30mm)
back to back set only

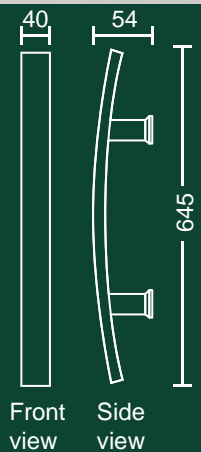

Archer



■ 3074S
450mm

Koji



Front view
Side view

CUSTOM TIMBER HANDLES



■ 3133TC
Timber Helio
Cedar

stainless
steel
43mm cap
options

pancake

domed

convex

■ 3131TS
timber carillon

■ 3134T
full square grip

■ 3132T
full round grip

■ 3130TS
half round
grip

■ 3135T
D pull grip

■ 3128TS
full height
pole + caps

■ 3129T
full height
block grip

■ 3127T
full height
long grip

■ 3091BT
timber rope



Got ideas?
We can make almost any
timber handle design

Woodworkers custom manufacture timber handles to achieve various architectural effects in red cedar, rosewood, Vic. Ash or other woods on request using computer controlled CNC machining. Custom handles are fabricated for each specific application and can be moulded to an infinite variety of design options. POA

■ 3133TO
Timber Helio
Oak



pivot
door
with
custom
timber
handle

GOLD HANDLES

Timber Connaught

■ 3030GT 600mm
■ 3029GT 450mm

Front view Side view

Amman

■ 3002G/L 520mm left handed
■ 3002G/R 520mm right handed
■ 3001G/R 315mm right handed
■ 3001G/L 315mm left handed

Front view Side view

Koji

■ 3074G 450mm back to back set only

Front view Side view

Woodworkers PVD gold pull handles have a stainless steel core finished in the most durable of all finishes with a lifetime warranty not to tarnish

Sizzle

■ 3102G/L 545mm left handed
■ 3102G/R 545mm right handed

Front view Side view

Sizzle

■ 3101G/R 300mm right handed
■ 3101G/L 300mm left handed

Front view Side view

see our roller locks selection suitable for use with presentation pull handles.

gold emanates prestige

Connaught

■ 3028G 600mm
■ 3027G 450mm

Front view Side view

Classic

■ 3025G 460mm
■ 3024G 350mm

Front view Side view

Czar Gold

■ 3144G 755mm

Gold Finish

shaft 38mm diameter

Front view Side view

Hip

DISCONTINUED

Front view Side view

COPPER + PATINA HANDLES



■ 3006C/L
540mm
left handed
back to back
set only

PVD
Copper
Finish

■ 3006C/R
540mm
right handed
back to back
set only

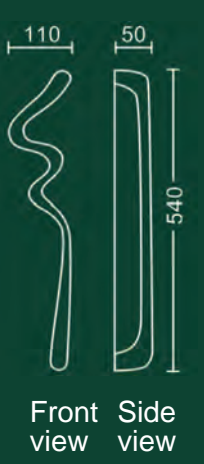

Front view
Side view

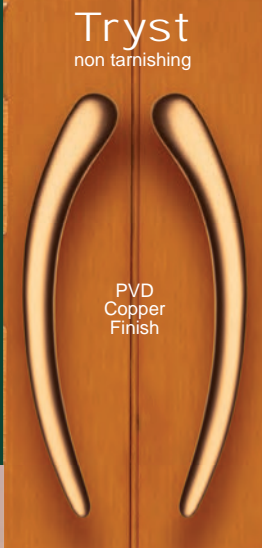

■ 3123C/L
450mm
left handed
back to back
set only

■ 3123C/R
450mm
right handed
back to back
set only

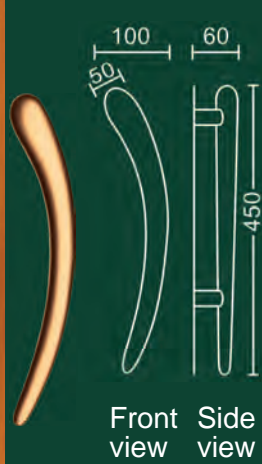

Front view
Side view

■ 3122C/R
340mm right handed
back to back set only

■ 3122C/L
340mm left handed
back to back set only



■ 3102C/L
545mm
left handed

■ 3102C/R
545mm
right handed

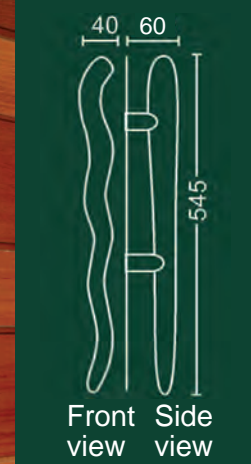

Front view
Side view

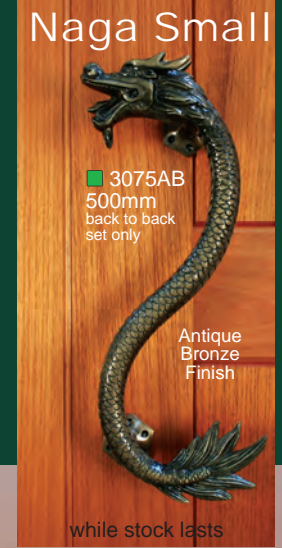

■ 3075AB
500mm
back to back
set only

Antique
Bronze
Finish

while stock lasts



Front view
Side view

Woodworkers contemporary copper range have a stainless steel core finished in copper PVD - the most durable of all finishes with a lifetime warranty not to tarnish

copper ages to a gentle patina



Czar Gold

■ 3144G
755mm

Gold
Finish

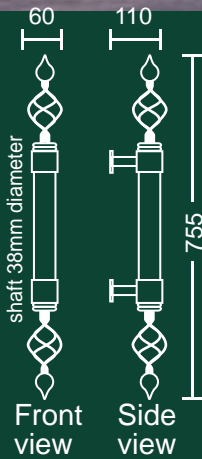

Front view
Side view



Antique Raj

■ 3005AB
470mm

Antique
Bronze
Finish

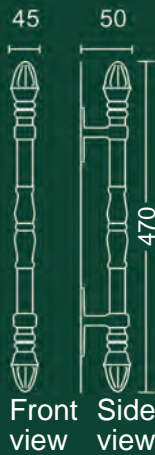

Front view
Side view



Venezia



■ 3143AB
800mm



Front view
Side view

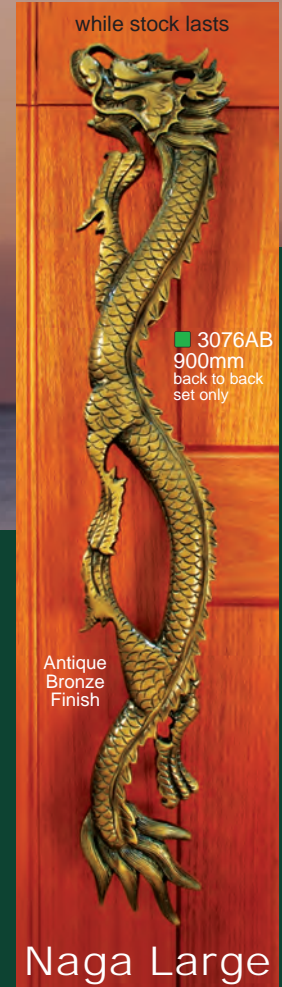

Naga Large

■ 3076AB
900mm
back to back
set only

Antique
Bronze
Finish

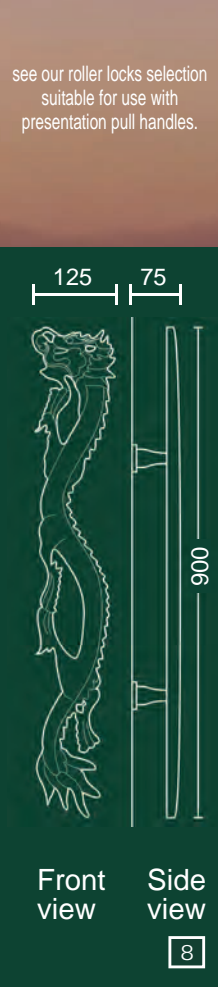

Front view
Side view

see our roller locks selection
suitable for use with
presentation pull handles.

BLACK HANDLES

Black Helio

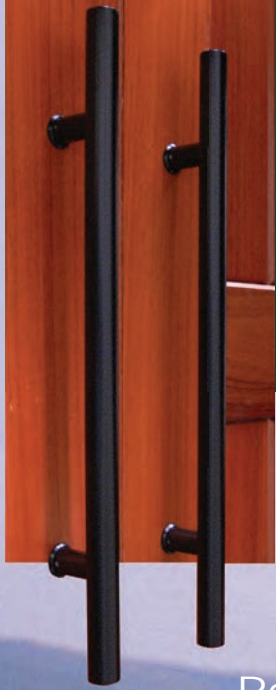

■ 3042B
600mm
back to back set only

Triffid

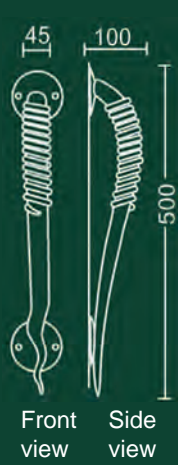

see our roller locks selection suitable for use with presentation pull handles.

■ 3121B
500mm

Andalucia



also available
■ 3003B
325mm

■ 3004B
470mm

Barcelona

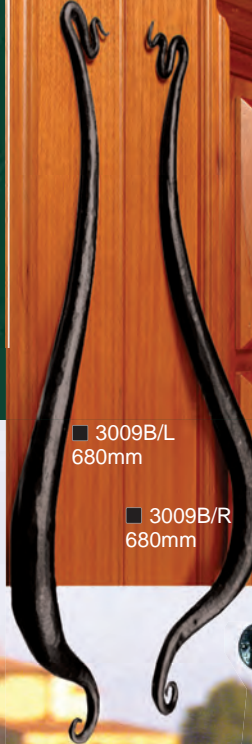

■ 3009B/L
680mm

■ 3009B/R
680mm

Cadiz

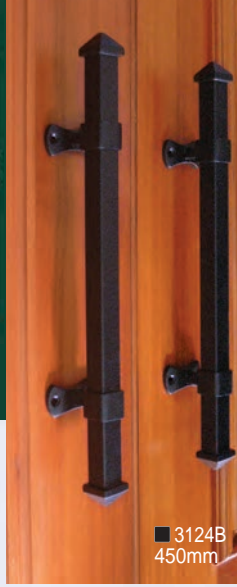

■ 3124B
450mm

Rope

■ 3091B
400mm
white stocks
last

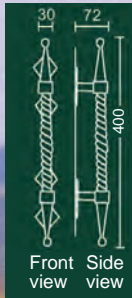

black is bold + evocative

■ 3071AS
370mm
antique
silver

■ 3070AS
260mm

■ 3071R
370mm
rusty

■ 3070R
260mm



detail of BAYOU coil grip



Black Cavus

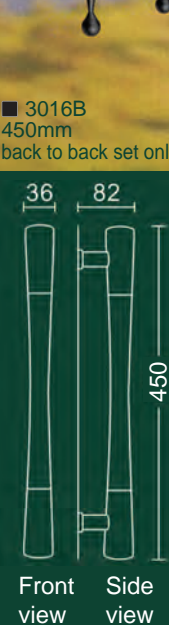

■ 3016B
450mm
back to back set only



Vine



also available
■ 3007B
300mm



Bangalow

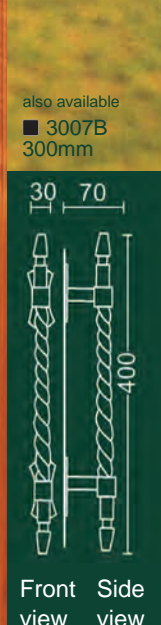

also available
■ 3007B
300mm



Ironbridge



■ 3071B
370mm

■ 3070B
260mm



Bayou

■ 3126B
420mm

mat black

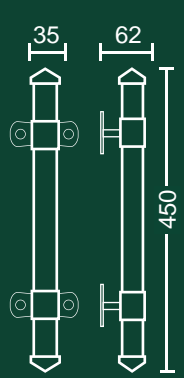

Front view Side view

Finesse

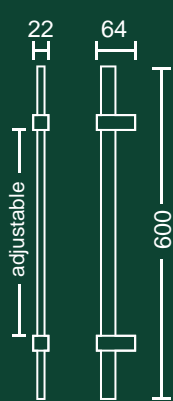

Front view Side view

Black Neo



Front view Side view

Archer

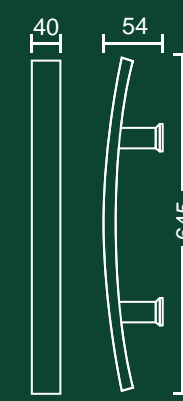

Front view Side view

Luna



Front view Side view

■ 3036B
600mm
back to back set only
adjustable

■ 3080B
600mm
back to back set only

also available
■ 3084B
1200mm
back to back set only

■ 3151B
645mm
back to back set only

also available
■ 3150B
450mm
back to back set only

■ 3155B
220mm
back to back set only



3126AC 420mm
3126AB 420mm
3126G 420mm



Czar Black

■ 3144B
755mm

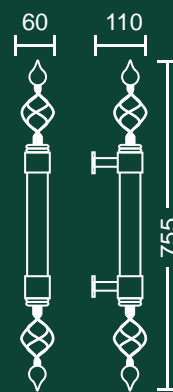

Front view Side view



Granada

■ 3146B
487mm

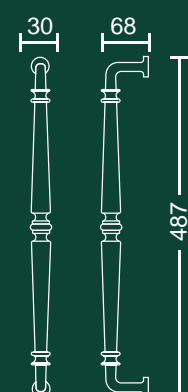

Front view Side view



Granada on Plate

■ 3147B
380mm

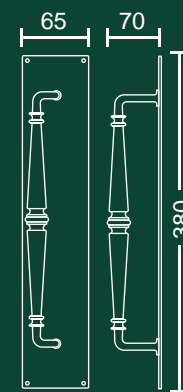

Front view Side view



Dais

■ 3153B
240mm
back to back set only



Front view Side view

woodworkers lever handles

SILVER LEVER HANDLES

■ 830S
heritage lever
on plate passage

■ 829S
heritage lever
on plate euro

■ 823S
cottage lever on
traditional plate euro

□ 827S
cottage lever on
slimline plate euro

THIS LEVER SUPPLIED IN
SILVER PREPACKAGED KITS

■ 854S
tokyo lever
on rose

■ 845S
nida lever
on rose

■ 833S
soho lever
on rose

■ 826S
cottage lever
on rose

□ 834S
berlin lever on
square plate

GOLD LEVER HANDLES

■ 830G
heritage lever
on plate passage

■ 829G
heritage lever
on plate euro

THIS LEVER SUPPLIED IN
GOLD PREPACKAGED KITS

■ 823G
cottage lever on
traditional plate euro

■ 827G
cottage lever
on slimline plate euro

■ 826G
cottage lever
on rose

BLACK LEVER HANDLES

■ 841B
baltimore lever
on plate euro

■ 829B
heritage lever
on plate euro

THIS LEVER SUPPLIED IN
BLACK PREPACKAGED KITS

■ 823B
cottage lever
on traditional
plate euro

■ 827B
cottage lever on
slimline plate euro

■ 834B
berlin lever
on square plate

woodworkers barn door sliding hardware

premium range - 80kg

Suitable for single or double door operation. Single door kits sold in five kit sizes with 2m - 4m open rail track. Double door kits sold in four kit sizes with 3m - 5m open rail track. Available with both black and stainless steel hardware. Suitable for one or two doors to cover the opening on a single track. Doors may slide in one or both directions. For internal use only on doors 35 - 45mm thick



- 7015S
- 7015B
see pricelist for other options
- SINGLE DOOR KITS** comprises
 - 2 hangers
 - 2 track stops
 - 1 floor guide
 - 1 mounting bracket per 450mm of track
 - 2 end caps
 - 2 floor stops
 - 1 length of track
- 7016S
- 7016B
see pricelist for other options
- DOUBLE DOOR KITS** comprises
 - 4 hangers
 - 4 track stops
 - 2 floor guides
 - 1 mounting bracket per 450mm of track
 - 2 end caps
 - 2 floor stops
 - 1 length of track

stainless steel kit components

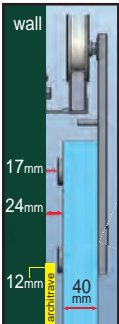

black powdercoat kit components

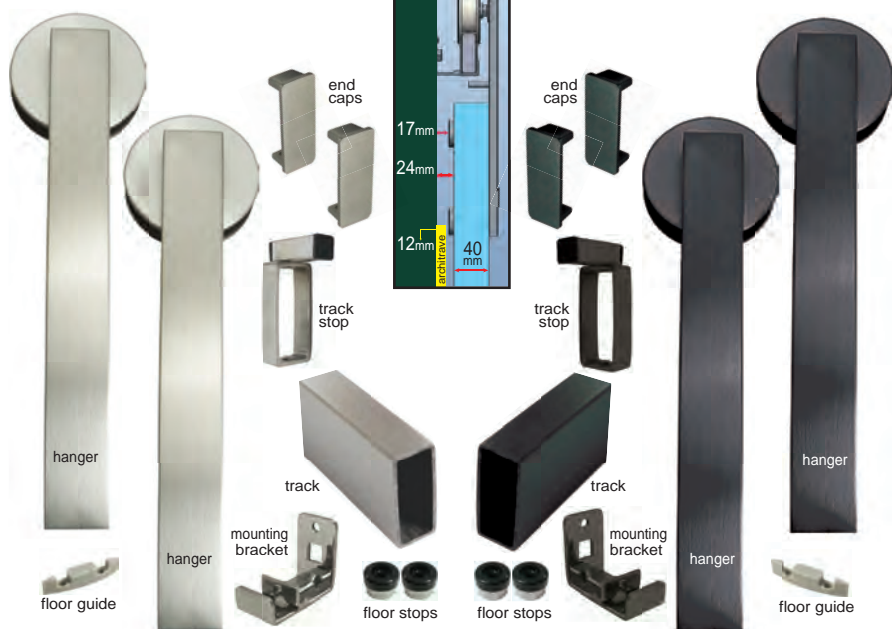

budget range - 40kg

Suitable for single door operation. Kits sold with 2m long track only. Hanging hardware available in black or off-white. For internal use only on doors 35-45mm thick.

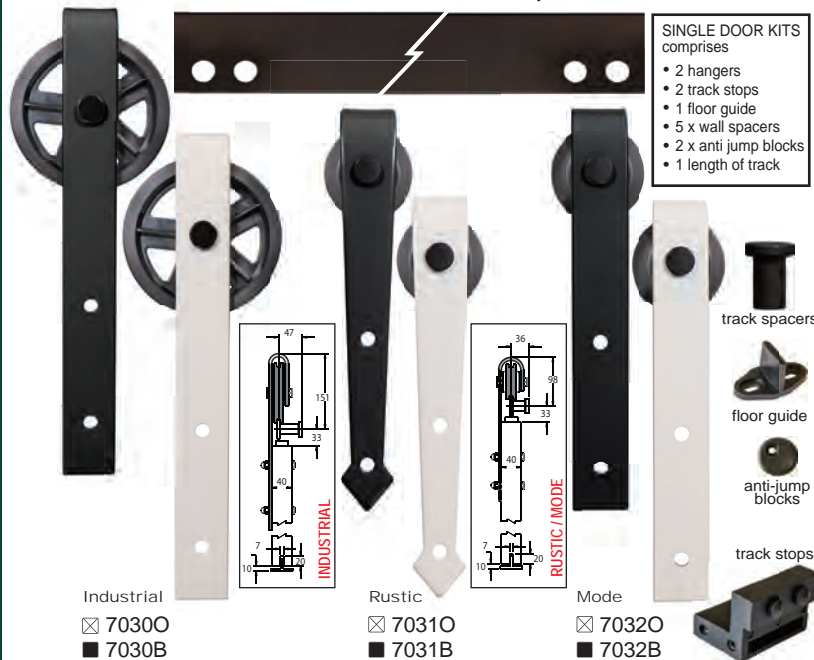

Please note all off white tracks and accessories come with black wheels and fixings standard

barn door accessories

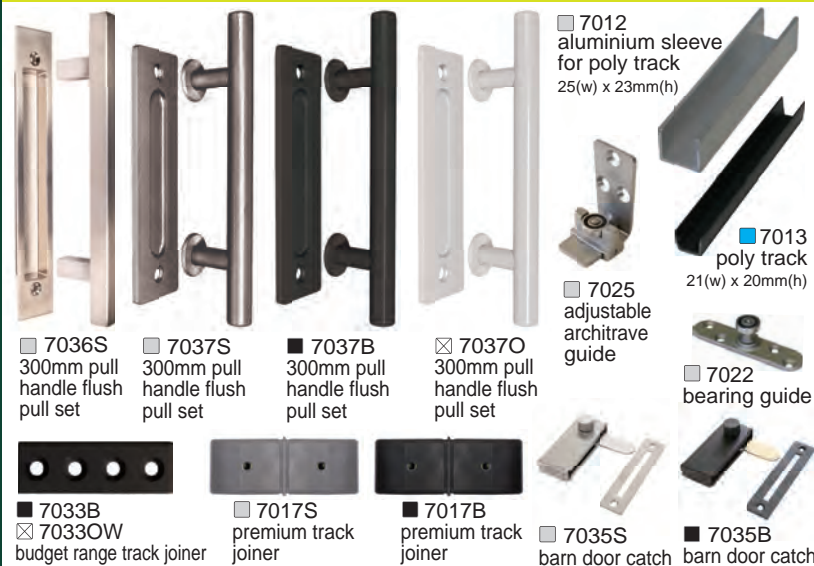

internal bifold range - 40kg



door hardware

woodworkers door lock guide



ROLLER LOCKS

Roller locks restrain a door with a spring mounted roller shaped latch rather than a conventional wedge type latch that requires mechanical retraction. This allows the use of presentation pull handles (as no knob or lever is required) giving a contemporary uncluttered look. Like other locks there is an independent dead bolt to totally lock the door when required. Roller locks are available only with euro cylinder mechanisms and can be used in rebated door or single door applications.



EURO LATCH LOCKS

These are high security locks used on external doors suitable for modern euro cylinders. You can choose either a double-ended cylinder (where a key can be used from either end) or a thumb-turn cylinder (key for outside, thumb turn inside). They are morticed into the door stile so the lock mechanism is concealed from view. Euro cylinders can be masterkeyed as necessary to allow different access levels.



REBATED LATCH LOCKS

These are used when you have one door closing into another door, which is traditionally done on French Doors and Double Entry Doors. Rebated locks have a 13mm rebate in the face plate and strike and are available in Euro Lock, Skeleton Key Lock or you can use a Rebate Kit on a Tube Latch.



SLIDING LOCKS

Sliding or Parrot's Beak Locks are locks with claw hooks to grab onto the opposing striker plate to secure a sliding door. They can have flat or half moon faces (known as astragal) and can be used internally or externally with either euro cylinder or skeleton key operation.



SKELETON KEY LOCKS

These can be 5 Lever High Security Locks, to be used on external doors, or 3 Lever Low Security Locks to be used on internal doors. The difference between 5 Lever and 3 Lever Locks is the number of different key combinations available. These locks are supplied with a "skeleton" key. The main difference is that the 3 and 5 Lever Locks are more "traditional" for period homes but they cannot be master keyed.



RIM LOCKS

These are low security locks that screw to the outer surface of the door (as opposed to a mortice lock, which is "morticed" into the door). Rim Locks require knobs with a threaded spindle, where the knob screws onto the threaded spindle and is secured by grub screws. Rim Locks are suitable for inward opening doors only and are not suitable for rebated doors. They are also known as carpenter's locks.



DEADBOLTS

Deadbolts are part of most other lock varieties and are the bolt that locks the door, designed in conjunction with latch or roller mechanisms that restrain the door but don't lock it. Deadbolts are also available as separate mortice or surface mounted units for supplementary security.



DEADLATCHES

These latches can be retracted by a key from either side or a knob or lever from the inside only. They can be either rim or mortice locks.



TUBE LATCHES

This is used when the door doesn't need to be locked. It can be used with any type of lever or knob door furniture. Latch simply means you need a Tube Latch to make your door furniture functional.



PRIVACY LATCH

These latches can be used on Bedroom or Bathroom Doors. They have a thumb turn on one side and a safety release on the other side of the tubelatch.



EASY FIT DEAD BOLTS

These are the simplest deadbolt to fix requiring two drilled holes and a surface mounted lock. They are available for single and double door applications.



ELECTRONIC + KEYLESS LOCKS

Smart locks have become popular because of the ease of installation and the amount of control it gives the owner. These locks don't need to be hardwired as they have batteries and can connect directly, or through a hub or bridge to your home WiFi. Depending on the model chosen you can control the lock via keypad, smartphone, tag, fingerprint or mechanical key. Smart locks can allow for remote locking and unlocking as well as over 100 permanent or time-controlled access codes. Mechanical keyless locks still have their place where WiFi or electricity isn't available.



PART 2

hardware kits



Woodworkers hardware kits make hardware selection simple and economical. All the components required are in a simple kit which is supplied keyed alike for convenience. All kits contain proven high quality hardware specifically engineered for our timber joinery that are bulk packaged to reduce costs.

woodworkers standard door hardware kits



NOTE: HINGES ARE NOT INCLUDED IN STOCK KITS



All butt hinges are ballbearing stainless construction

| | silver | gold | black |
|------------------------|-----------------------|------|-------|
| BUTT HINGES | | | |
| item | code per single hinge | | |
| 100 x 60 | 401S | 401G | NA |
| 100 x 75 | 402S | 402G | 402B |
| 100 x 100 | 403S | 403G | 403B |
| 100 x 125 | 404S | 404G | NA |
| 100 x 150 | 405S | 405G | NA |
| 100 x 200 | 406S | 406G | 406B |
| HIRLINE HINGES | | | |
| 100mm | 411S | 411G | 411B |
| LIFT OFF HINGES | | | |
| 100 x 75 | 421S/R | NA | NA |
| 100 x 75 | 421S/L | NA | NA |



watch our website videos on how to fit our locks



SINGLE ENTRY ROLLER KIT

2. Euro cylinder
10. Roller lock 60mm
12. Escutcheon pair
13. Magnetic stop

SINGLE ENTRY ROLLER KIT - SILVER

4021S KIT DESIGNED TO BE USED WITH PRESENTATION PULL HANDLES

SINGLE ENTRY ROLLER KIT - GOLD

4021G KIT DESIGNED TO BE USED WITH PRESENTATION PULL HANDLES

SINGLE ENTRY ROLLER KIT - BLACK

4021B KIT DESIGNED TO BE USED WITH PRESENTATION PULL HANDLES

DOUBLE ENTRY ROLLER KITS

2. Euro double cylinder
12. Escutcheon pair
13. Magnetic door stop - floor x 2
27. Mortice lock roller rebated
29. Keyed offset flush bolt 190mm x 2

DOUBLE ENTRY ROLLER KIT - SILVER

4022S KIT DESIGNED TO BE USED WITH PRESENTATION PULL HANDLES

DOUBLE ENTRY ROLLER KIT - GOLD

4022G KIT DESIGNED TO BE USED WITH PRESENTATION PULL HANDLES

DOUBLE ENTRY ROLLER KIT - BLACK

4022B KIT DESIGNED TO BE USED WITH PRESENTATION PULL HANDLES

PIVOT DOOR KIT

2. Euro double cylinder
10. Roller lock 60mm
12. Escutcheon pair
13. Magnetic stop
15. Extended strike
16. Deadbolt mortice lock

PIVOT DOOR BOLT KIT - SILVER

4023S KIT DESIGNED TO BE USED WITH PRESENTATION PULL HANDLES

PIVOT DOOR BOLT KIT - GOLD

4023G KIT DESIGNED TO BE USED WITH PRESENTATION PULL HANDLES

PIVOT DOOR BOLT KIT - BLACK

4023B KIT DESIGNED TO BE USED WITH PRESENTATION PULL HANDLES

PIVOT DOOR ROLLER KIT - SILVER

4024S KIT DESIGNED TO BE USED WITH PRESENTATION PULL HANDLES

PIVOT DOOR ROLLER KIT - GOLD

4024G KIT DESIGNED TO BE USED WITH PRESENTATION PULL HANDLES

PIVOT DOOR ROLLER KIT - BLACK

4024B KIT DESIGNED TO BE USED WITH PRESENTATION PULL HANDLES

woodworkers standard door hardware kits

INTERNAL PASSAGE + PRIVACY KIT

INTERNAL PASSAGE + PRIVACY KIT



1. Passage lever handle set
11. Privacy snib & bolt
17. Tube latch

INTERNAL PASSAGE KIT - SILVER



INTERNAL PRIVACY KIT - SILVER



INCLUDES 4003S PASSAGE KIT

INTERNAL PASSAGE KIT - GOLD



INTERNAL PRIVACY KIT - GOLD



INCLUDES 4003G PASSAGE KIT

INTERNAL PASSAGE KIT - BLACK



INTERNAL PRIVACY KIT - BLACK



INCLUDES 4003B PASSAGE KIT

MULTIFOLD 1 WAY KIT

MULTIFOLD 1 WAY KIT

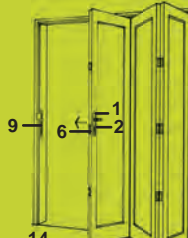

1. Euro lever handle set
2. Euro double cylinder
6. Mortice lock 48cc
9. Extended strike
14. Magnetic door stop - Wall

1 WAY KIT - SILVER



1 WAY KIT - GOLD



1 WAY KIT - BLACK

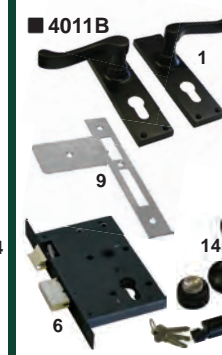

SINGLE ENTRY LEVER KIT

SINGLE ENTRY LEVER KIT

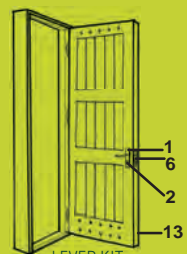

1. Euro lever handle set
2. Euro cylinder
6. Mortice lock 48cc
13. Magnetic stop

SINGLE ENTRY LEVER KIT - SILVER

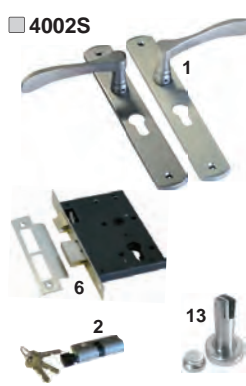

SINGLE ENTRY LEVER KIT - GOLD

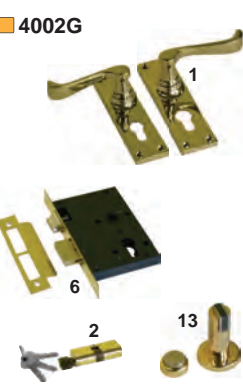

SINGLE ENTRY LEVER KIT - BLACK

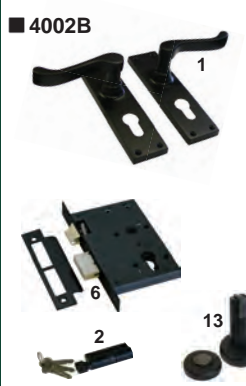

MULTIFOLD REBATED KIT

MULTIFOLD REBATED KIT

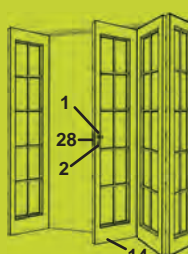

1. Euro lever handle set
2. Euro double cylinder
14. Magnetic door stop x 2 - Wall
28. Mortice lock rebated 48cc

REBATED KIT - SILVER



REBATED KIT - GOLD



REBATED KIT - BLACK

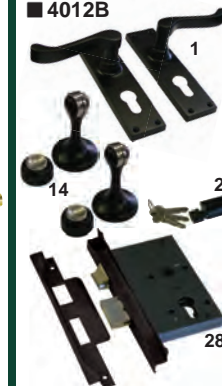

FRENCH DOOR / DOUBLE ENTRY LEVER KIT

FRENCH DOOR + DOUBLE ENTRY LEVER KIT



1. Euro lever handle set
2. Euro double cylinder C4 65mm
3. Keyed flush bolt 190mm
4. Non-keyed flush bolt 190mm
5. Silent pattern cabin hook 150mm x 2
13. Magnetic door stop - floor x 2
28. Mortice lock rebated 48cc
29. Keyed offset flush bolt 190mm x 2

FRENCH DOOR / DOUBLE ENTRY LEVER KIT - SILVER

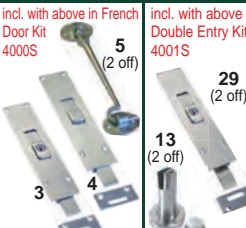
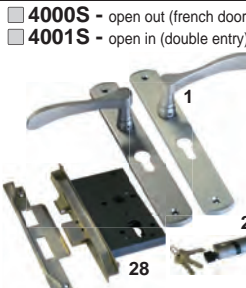

FRENCH DOOR / DOUBLE ENTRY LEVER KIT - GOLD

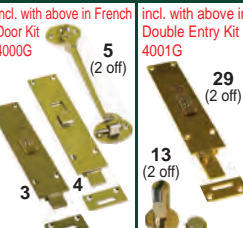
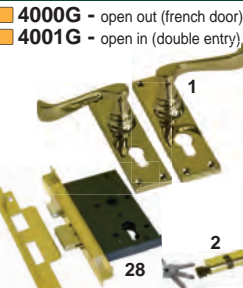

FRENCH DOOR / DOUBLE ENTRY LEVER KIT - BLACK

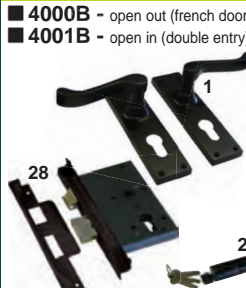

VERANDAH GATE SINGLE

CONTEMPORARY 1 GATE KIT

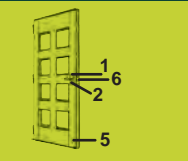

1. Euro lever handle set
2. Euro double cylinder
5. Silent pattern cabin hook 150mm
6. Mortice lock

SINGLE KIT - SILVER

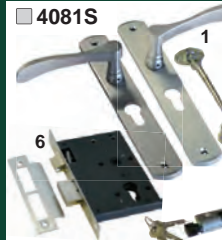

SINGLE KIT - GOLD

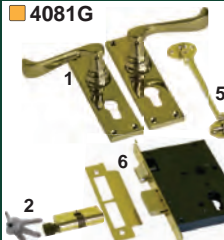

SINGLE KIT - BLACK

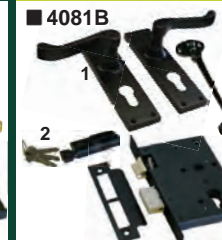

VERANDAH GATE PAIR

CONTEMPORARY 2 GATE KIT



1. Euro lever handle set
2. Euro double cylinder
5. Silent pattern cabin hook x 2
23. Panic bolt
28. Mortice lock rebated 48cc

DOUBLE KIT - SILVER



DOUBLE KIT - GOLD

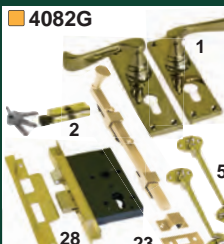

DOUBLE KIT - BLACK



door hardware kits

woodworkers door hardware kits

entry kit

door hardware kits

SLIDING DOOR KIT - OX

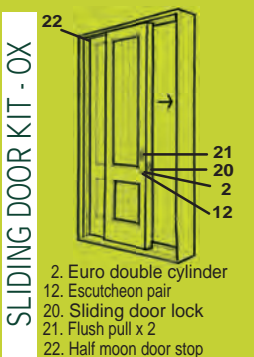

SLIDING DOOR KIT - OX - SILVER

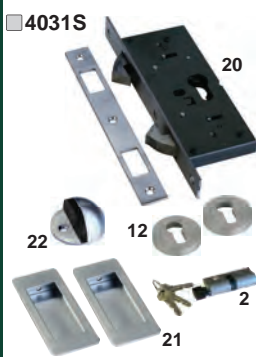

SLIDING DOOR KIT - OX - GOLD



SLIDING DOOR KIT - OX - BLACK



SECURITY DOUBLE DOOR KIT



SECURITY DOUBLE DOOR KIT - SILVER



SECURITY DOUBLE DOOR KIT - GOLD

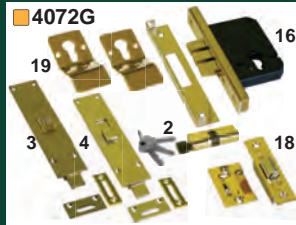

SECURITY DOUBLE DOOR KIT - BLACK



SLIDING REBATED DOORS OXOX



SLIDING REBATED DOORS OXOX - SILVER

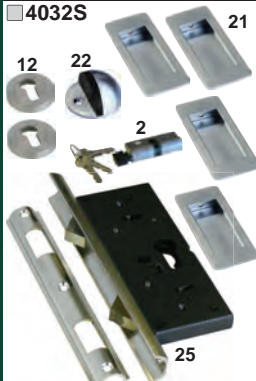

SLIDING REBATED DOORS OXOX - GOLD



SLIDING REBATED DOORS OXOX - BLACK



SECURITY DOUBLE DOOR KIT

get a 33% discount on morticing locks + flush bolts when you buy our Kits



TRADITIONAL VERANDAH GATE

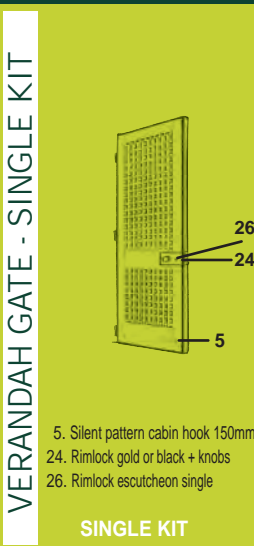

SINGLE KIT - POLISHED BRASS



SINGLE KIT - POLISHED BRASS/BLACK



SINGLE KIT - BLACK



TRADITIONAL VERANDAH GATE

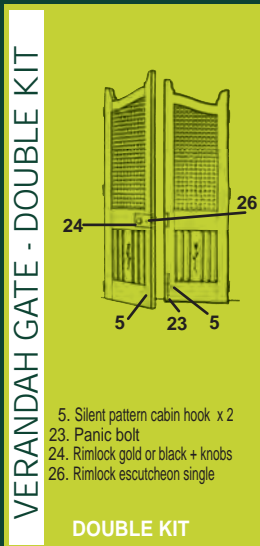

DOUBLE KIT - POLISHED BRASS



DOUBLE KIT - POLISHED BRASS/BLACK



DOUBLE KIT - BLACK



SECURITY SINGLE DOOR KIT



SECURITY SINGLE DOOR KIT - SILVER



SECURITY SINGLE DOOR KIT - GOLD

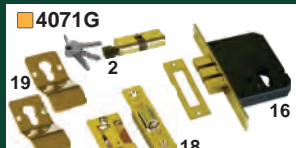

SECURITY SINGLE DOOR KIT - BLACK



CHOOSE EITHER 1 PAIR OF HELIO or NEO 600 304 STAINLESS STEEL HANDLES

you'll save a bundle when you buy our bundles



+



HELIO or NEO
600mm
304 STAINLESS STEEL
HANDLES

Special bundle buys

COLUMN A
ALTERNATIVE HANDLES

PRICE CODE 3

 soho
 tokyo
 nida
 berlin
 berlin

PRICE CODE 2

 cottage on traditional black
 cottage on traditional silver
 cottage on traditional gold

 cottage on rose
 cottage on rose

PRICE CODE 1

 heritage on plate
 cottage on slimline
 cottage on slimline

INTERNAL PASSAGE + PRIVACY KIT

1. Passage lever handle set
11. Privacy snib & bolt
17. Tube latch

INTERNAL PASSAGE KIT - SILVER

- 4403S
- 4403G
- 4403B

 17

INTERNAL PRIVACY KIT - SILVER

- 4404S
- 4404G
- 4404B

 11

includes passage kit

SINGLE ENTRY LEVER KIT

1. Euro lever handle set
2. Euro double cylinder
8. Mortice lock
12. Escutcheon pair
13. Magnetic stop floor

- 4402S
- 4402G
- 4402B

 8
 12
 13
 2

escutcheons as required for rose options only

FRENCH DOOR / DOUBLE ENTRY LEVER KITS

1. Euro lever handle set
2. Euro double cylinder
3. Keyed flush bolt 190mm
4. Non-keyed flush bolt 190mm
5. Cabin hook 150mm x 2
7. Mortice rebated latch lock
12. Escutcheon pair
13. Magnetic stop floor x 2
29. Keyed offset flush bolt 190mm x 2

french door Double Entry Kits

- 4400S
- 4400G
- 4400B

double entry Double Entry Kits

- 4401S
- 4401G
- 4401B

 2
 12
 7

escutcheons as required for rose options only

included with above French Door Kits 4000S, 4000G, 4000B

 5 (2 off)
 29 (2 off)
 13 (2 off)

MULTIFOLD 1 WAY KIT

1. Euro lever handle set
2. Euro double cylinder
8. Mortice lock
12. Escutcheon pair
14. Magnetic door stop - Wall
15. Extended strike

ALTERNATIVE HANDLE KIT

- 4411S
- 4411G
- 4411B

 8
 12
 14
 15

escutcheons as required for rose options only

MULTIFOLD REBATED KIT

1. Euro lever handle set
2. Euro double cylinder
7. Mortice lock rebated
12. Escutcheon pair
14. Magnetic stop x 2 - Wall

ALTERNATIVE HANDLE KIT

- 4412S
- 4412G
- 4412B

 2
 12
 14
 7

escutcheons as required for rose options only

VERANDAH GATE PAIR

1. Euro lever handle set
2. Euro double cylinder
5. Cabin hook 150mm x 2
7. Mortice lock rebated
12. Escutcheon pair
23. Panic bolt

ALTERNATIVE HANDLE KIT

- 4482S
- 4482G
- 4482B

 5
 12
 7
 23

escutcheons as required for rose options only

VERANDAH GATE SINGLE

1. Euro lever handle set
2. Euro double cylinder
5. Cabin hook 150mm
8. Mortice latch lock
12. Escutcheon pair

ALTERNATIVE HANDLE KIT

- 4481S
- 4481G
- 4481B

 5
 12
 2
 8

escutcheons as required for rose options only

lock + bolt morticing

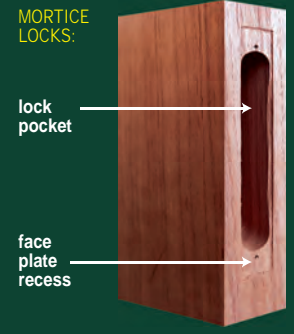

Woodworkers provide a service to machine out lock pockets and flush bolt routings to suit our hardware only. Price does not include installation of the hardware but does cover the trenching for the lock body and plate as shown but NOT for the striker plate, cylinder or spindle holes which need to be done on site by others. This permits flexibility for both single and double sided hardware to be fitted on site to suit the application. When Woodworkers hardware is ordered a discount applies to the morticing as a package

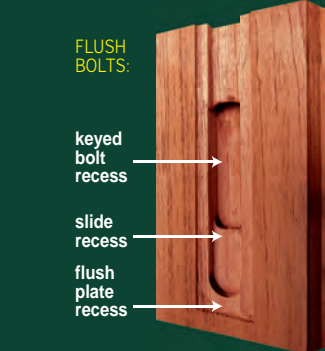

Flush bolt routing is for Woodworkers own keyed or non keyed flush bolts only and does NOT include striker plate checkout and the installation of the flush bolts which is done on site by others



door lock preparation & installation video

alternative kits using different lever handle styles chosen from column A

alternative kits using different lever handle styles chosen from column A

we design

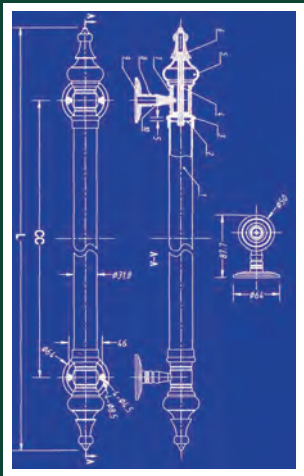

we produce



we import

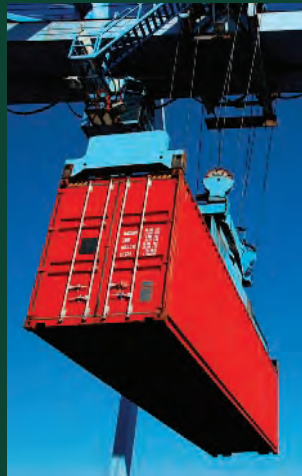

we simplify



we advise



we coordinate





PART 3

hardware components

Woodworkers are door and window hardware specialists. This means we carry many products unique to our specialty that you won't find elsewhere. Many of these products we manufacture ourselves and others we buy in to ensure we offer you the widest range available. Our aim is to make outfitting timber joinery with attractive and coordinated hardware stress free and affordable.

woodworkers lever handles

lever handles

85cc

- 823S cottage on traditional plate euro
- 825S cottage on traditional plate privacy
- 824S cottage on traditional plate passage

no integral privacy option available for this handle.

48cc

- 827S cottage on slimline plate euro
- 828S cottage on slimline plate passage

no integral privacy option available for this handle.

48cc

- 829S heritage lever on plate euro
- 830S heritage lever on plate passage

no integral privacy option available for this handle.

85cc

- 834S berlin lever on square
- 833S soho lever on rose
- 854S tokyo lever on rose
- 826S cottage lever on rose

85cc

- 823G cottage on traditional plate euro
- 825G cottage on traditional plate privacy
- 824G cottage on traditional plate passage

no integral privacy option available for this handle.

48cc

- 827G cottage on slimline plate euro
- 828G cottage on slimline plate passage

no integral privacy option available for this handle.

48cc

- 829G heritage lever on plate euro
- 830G heritage lever on plate passage

no integral privacy option available for this handle.

85cc

- 826G cottage lever on rose
- 834B berlin lever on square

all lever handles on rose can be used for entry, passage and privacy applications by adding a separate escutcheon and latch function

LEGEND
* = scale reduced

85cc

- 823B cottage on traditional plate euro
- 824B cottage on traditional plate passage

no integral privacy option available for this handle.

48cc

- 827B cottage on slimline plate euro
- 828B cottage on slimline plate passage

no integral privacy option available for this handle.

48cc

- 829B heritage lever on plate euro
- 830B heritage lever on plate passage

no integral privacy option available for this handle.

85cc

- 841B baltimore lever on plate euro
- 842B baltimore lever on plate passage

refer to item code in current hardware pricelist for costings

woodworkers knobs + latch locks

85cc

845S nida lever on rose

we're hands on with handles!

viewers

566S adjustable door viewer 35 - 50mm

566G adjustable door viewer 35 - 50mm

855S toro entry handle set

856S Asti entry set

855B toro entry handle set

856G Asti entry set

48cc 847G victorian knob on plate passage

846G victorian knob on plate euro

48cc 847S victorian knob on plate passage

846S victorian knob on plate euro

573 dummy spindle for non operating levers and knobs

LEGEND
48cc = 48mm
57cc = 57mm
85cc = 85mm
 centre to centre between spindle and cylinder

847B victorian knob on plate passage

846B victorian knob on plate euro

821S victorian knob on rose

847AC victorian knob on plate passage

846AC victorian knob on plate euro

821G victorian knob on rose

no integral privacy option available for these knobs.

821B victorian knob on rose

843AC reeded knob on rose

821AC victorian knob on rose

843G reeded knob on rose

all knobs on rose can be used for entry, passage and privacy applications by adding a separate escutcheon & latch function

848WG porcelain knob on rose

849TG timber knob on rose

single door euro latch locks

1153S 45mm back set latch lock

1154S 60mm back set latch lock

silver **48cc**

104S 45mm back set latch lock

105S 60mm back set latch lock

silver **85cc**

1153G 45mm back set latch lock

1154G 60mm back set latch lock

gold **48cc**

104G 45mm back set latch lock

105G 60mm back set latch lock

gold **85cc**

Jackson latch locks
 1177 - 30 back set (pictured)
 1178 - 45 back set
 1179 - 60 back set
 available in silver gold black

1153B 45mm back set latch lock

1154B 60mm back set latch lock

black **48cc**

138B 45mm back set latch lock

139B 60mm back set latch lock

black **85cc**

[JACKSON] BLACK

double door rebated euro latch locks

2153S 45mm back set rebated latch lock

2154S 60mm back set rebated latch lock

silver **48cc**

rebated latch lock

2104S 45mm back set rebated latch lock

2105S 60mm back set rebated latch lock

silver **85cc**

2153G 45mm back set rebated latch lock

2154G 60mm back set rebated latch lock

gold **48cc**

2104G 45mm back set rebated latch lock

2105G 60mm back set rebated latch lock

gold **85cc**

Jackson latch locks
 2177 - 30 back set (pictured)
 2178 - 45 back set
 2179 - 60 back set
 available in silver gold black

2153B 45mm back set rebated latch lock

2154B 60mm back set rebated latch lock

black **48cc**

140B 45mm back set rebated latch lock

141B 60mm back set rebated latch lock

black **85cc**

[JACKSON] BLACK

refer to item code in current hardware pricelist for costings

knobs + latch locks

woodworkers latch + sliding + roller locks

skeleton key single latch locks



57cc

- 1180S 45mm backset latch lock
- 1181S 60mm backset latch lock

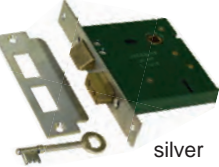

silver

57cc

- 1180G 45mm backset latch lock
- 1181G 60mm backset latch lock

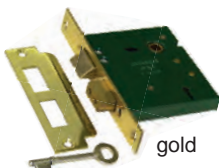

gold

57cc

- 1180B 45mm backset latch lock
- 1181B 60mm backset latch lock

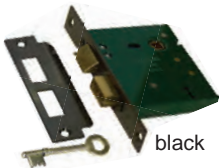

black

traditional 5 lever tumbler locks provide similar security to euro cylinder locks but cannot be master keyed.

skeleton key rebated latch locks

we've got the right lock for all situations.



- 2180S 45mm backset rebated latch lock



57cc

- 2181S 60mm backset rebated latch lock

- 2180G 45mm backset rebated latch lock

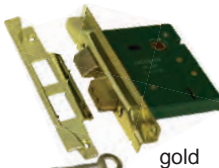

57cc

- 2181G 60mm backset rebated latch lock

- 2180B 45mm backset rebated latch lock

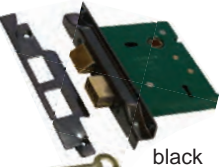

57cc

- 2181B 60mm backset rebated latch lock



sliding single door locks



- 126S flat sliding lock pictured 45mm backset



- 128S Jackson flat sliding lock 60mm backset

- 126G flat sliding lock pictured 45mm backset

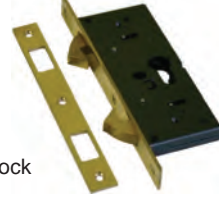

- 128G Jackson flat sliding lock 60mm backset

example shows 126S lock with 583S flush pull + 862S 45mm cylinder

- 127B flat sliding lock 45mm backset



[JACKSON]

- 128B flat sliding lock 60mm backset

skeleton key sliding locks

- 184S 45mm backset sliding lock

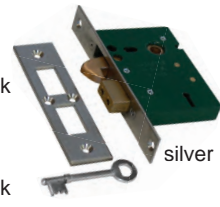

silver

- 185S 60mm backset sliding lock

- 184G 45mm backset sliding lock

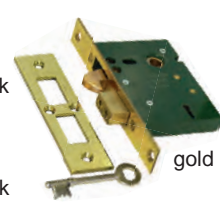

gold

- 185G 60mm backset sliding lock

- 184B 45mm backset sliding lock



black

- 185B 60mm backset sliding lock

[JACKSON]

single door mortice dead locks



- 133S 45mm backset deadlock



silver

- 134S 60mm backset deadlock

- 133G 45mm backset deadlock pictured

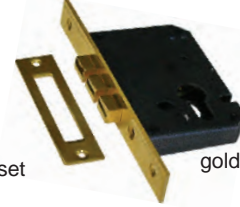

gold

- 137G Jackson 60mm backset deadlock

- 136B Jackson 45mm backset deadlock

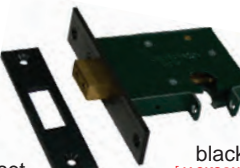

black

- 137B Jackson 60mm backset deadlock

we offer a keyed alike service with all our euro locks



sliding double door astragal locks



- 129S astragal sliding lock pictured 53mm backset



- 131S Jackson astragal sliding lock 60mm backset

- 129G astragal sliding lock pictured 53mm backset



- 131G Jackson astragal sliding lock 60mm backset

- 130B astragal sliding lock 45mm backset



[JACKSON]

- 131B astragal sliding lock 60mm backset

skeleton key astragal locks

- 186S 45mm backset astragal sliding lock

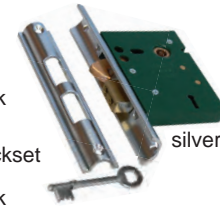

silver

- 187S 60mm backset astragal sliding lock

- 186G 45mm backset astragal sliding lock

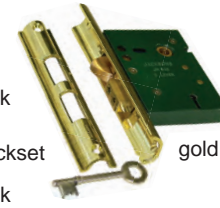

gold

- 187G 60mm backset astragal sliding lock

- 186B 45mm backset astragal sliding lock

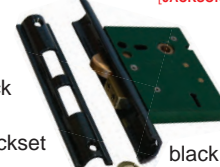

black

- 187B 60mm backset astragal sliding lock

[JACKSON]

rebated mortice dead locks



- 2133S 45mm backset rebated deadlock

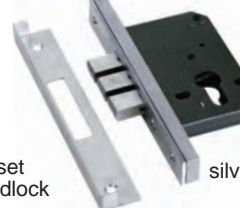

silver

- 2134S 60mm backset rebated deadlock

- 2133G 45mm backset rebated deadlock pictured



gold

- 175G Jackson 60mm backset rebated deadlock

- 174B Jackson 45mm backset rebated deadlock



black

- 175B Jackson 60mm backset rebated deadlock

door lock preparation & installation video



how to fit rebated door hardware video

woodworkers door hardware

single door euro roller locks



■ 106S
45mm
back set
roller lock



■ 107S
60mm
back set
roller lock

■ 106G
45mm
back set
roller lock

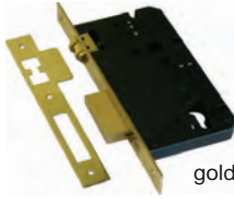

■ 107G
60mm
back set
roller lock

■ 106B
Tradco
45mm
back set
roller lock

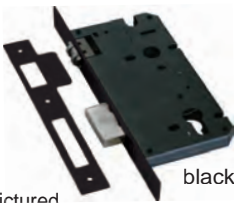

■ 107B
60mm
back set
roller lock pictured

double door rebated roller locks

roller locks are ideal for use with presentation pull handles

■ 2106S
45mm
backset
rebated
roller lock



■ 2107S
60mm
backset
rebated
roller lock

■ 2106G
45mm
backset
rebated
roller lock

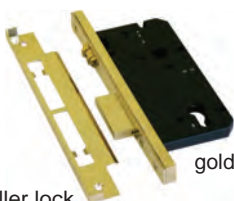

■ 2107G
60mm
backset
rebated
roller lock

■ 2106B
Tradco 45mm
backset
rebated roller
lock pictured



■ 2107B
60mm
backset
rebated
roller lock

roller locks are key retractable and avoid the need for knobs or levers.

rim locks

■ 853G
45mm milled
edge knob

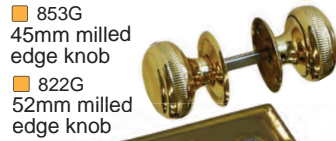

■ 822G
52mm milled
edge knob



■ 142G
rim lock 155 x 105mm



■ 169G
dead latch



■ 170S
■ 170G
■ 170B
cylinder
pull handle



■ 169B
■ 169S
dead latch



■ 853S
45mm milled
edge knob

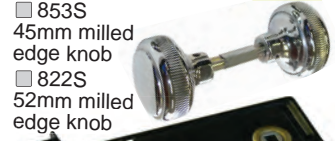

■ 822S
52mm milled
edge knob



■ 142BG
rim lock 155 x 105mm



■ 853B
45mm milled
edge knob



■ 822B
52mm milled
edge knob



■ 142B
rim lock 155 x 105mm

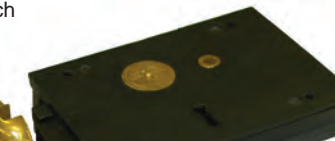

left hand
pictured

traditional 144AF
carpenters rim
lock face fixed
with 822G knob

■ 144AF/R right handed
■ 144AF/L left handed
carpenters rim lock 182 x 128mm



we've got authentic solutions for old houses.

■ 143AF/R right handed
■ 143AF/L left handed
carpenters rim lock 150 x 120mm

tubelatches



cottage lever
828S with
157S tubelatch
+ 161S privacy bolt

60mm
backset
privacy bolt

45mm
backset
privacy bolt

■ 161S
privacy
round

■ 199S
privacy
round

■ 161G
privacy
round

■ 199G
privacy
round

■ 161AC
privacy
round

■ 199AC
privacy
round

■ 161B
privacy
round

■ 199B
privacy
round

■ 159S
rebate kit



■ 159G
rebate kit



■ 159B
rebate kit



■ 159AC
rebate kit



match your internal and external handles to get a consistent look



■ 156S
45mm backset
split cam
tubelatch



■ 157S
60mm backset
split cam
tubelatch



■ 156G
45mm backset
split cam
tubelatch



■ 157G
60mm backset
split cam
tubelatch



■ 156B
45mm backset
split cam
tubelatch



■ 157B
60mm backset
split cam
tubelatch



■ 156AC
45mm backset
split cam
tubelatch



■ 157AC
60mm backset
split cam
tubelatch



locks + catches

woodworkers door hardware

hinges



extended strikes

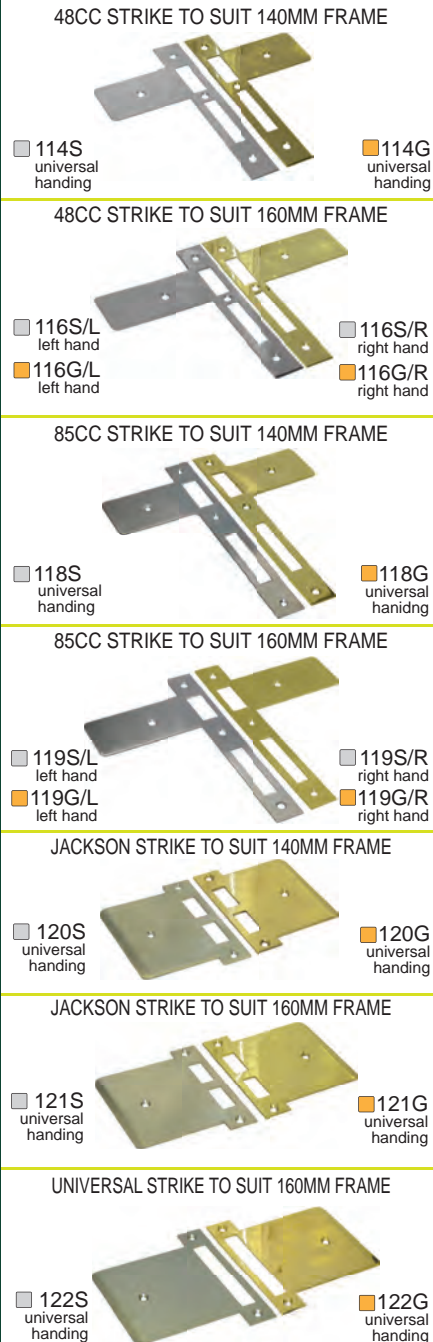

euro cylinders

what's so special about woodworkers **dual function** double euro cylinders?

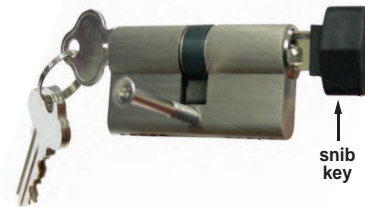

Most insurance companies insist on a deadlock on all entries to a house. Conventional cylinders can only be operated from one side at a time however. If you leave a key in one side of the cylinder you can't open the lock from the other side so now you're locked out!

With a dual function cylinder however, keys operate from both sides independently allowing the inside key to act as a temporary turnsnib for convenience. This turnsnib capability makes access easy when you're at home and can be quickly removed to comply with insurance deadlock requirements when you're out. Dual function euro cylinders are a great design innovation and are included in all standard Woodworkers entry hardware kits.



escutcheons

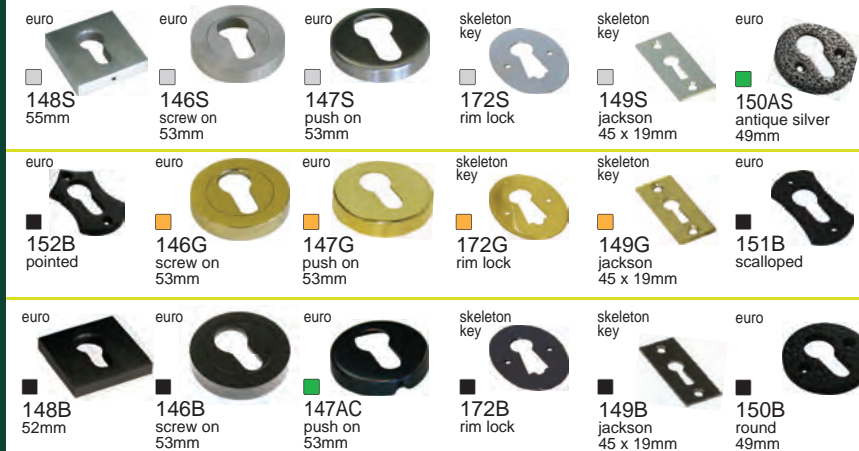

woodworkers locks + catches

easy fit cylinder levers

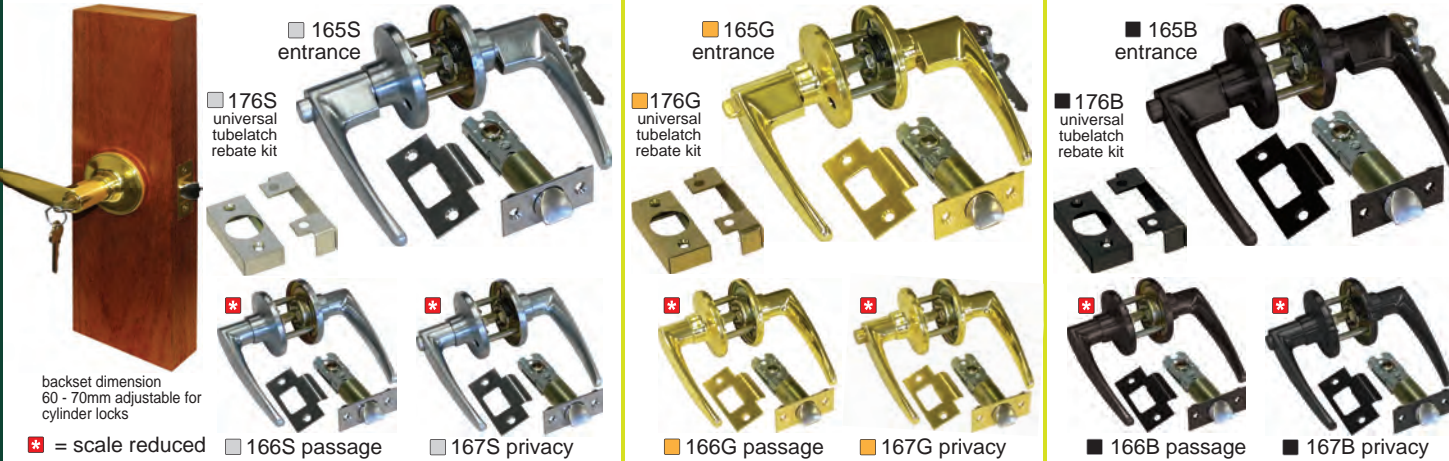

backset dimension 60 - 70mm adjustable for cylinder locks

* = scale reduced

| | | |
|---|---|---|
| <p>165S entrance</p> <p>176S universal tubelatch rebate kit</p> <p>166S passage</p> <p>167S privacy</p> | <p>165G entrance</p> <p>176G universal tubelatch rebate kit</p> <p>166G passage</p> <p>167G privacy</p> | <p>165B entrance</p> <p>176B universal tubelatch rebate kit</p> <p>166B passage</p> <p>167B privacy</p> |
|---|---|---|

easy fit cylinder knobs

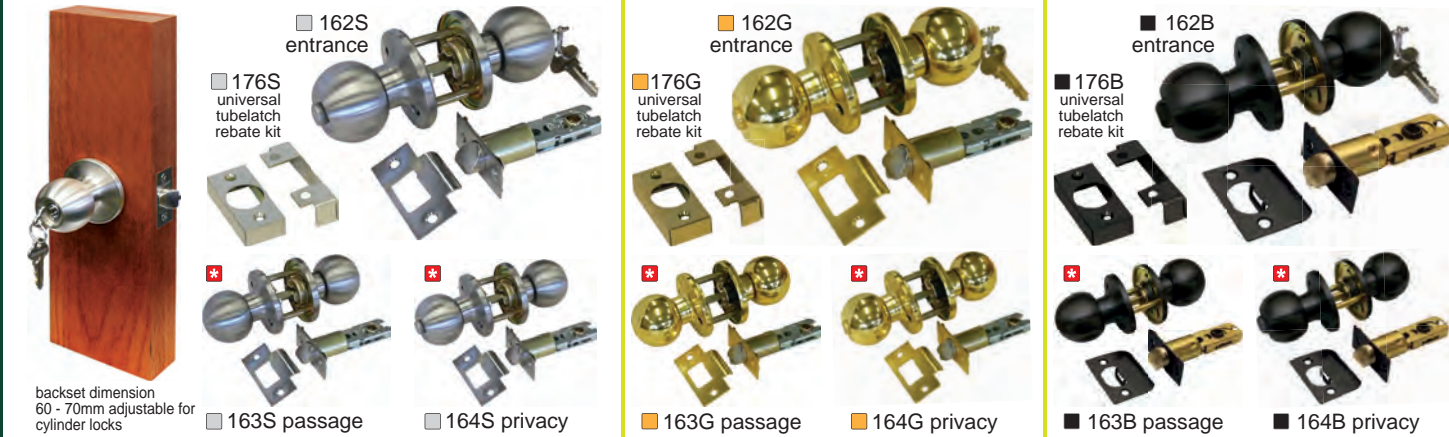

backset dimension 60 - 70mm adjustable for cylinder locks

* = scale reduced

| | | |
|---|---|---|
| <p>162S entrance</p> <p>176S universal tubelatch rebate kit</p> <p>163S passage</p> <p>164S privacy</p> | <p>162G entrance</p> <p>176G universal tubelatch rebate kit</p> <p>163G passage</p> <p>164G privacy</p> | <p>162B entrance</p> <p>176B universal tubelatch rebate kit</p> <p>163B passage</p> <p>164B privacy</p> |
|---|---|---|

easy fit dead bolts

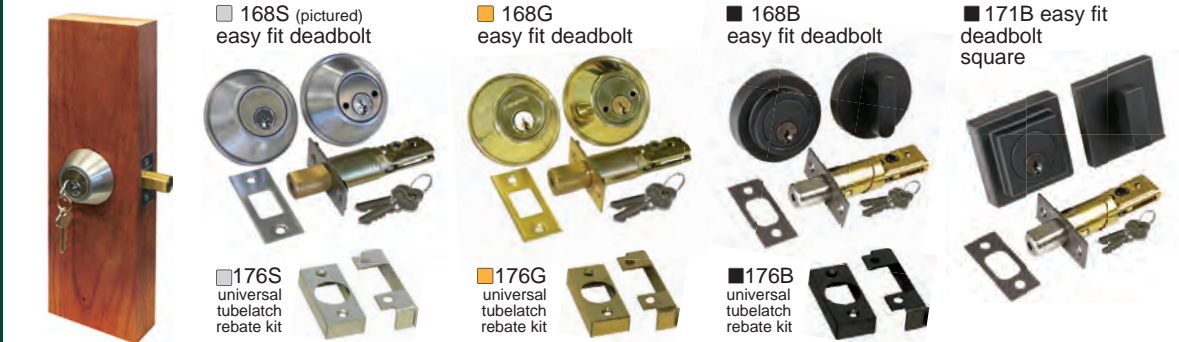

| | | | |
|---|--|--|--------------------------------------|
| <p>168S (pictured) easy fit deadbolt</p> <p>176S universal tubelatch rebate kit</p> | <p>168G easy fit deadbolt</p> <p>176G universal tubelatch rebate kit</p> | <p>168B easy fit deadbolt</p> <p>176B universal tubelatch rebate kit</p> | <p>171B easy fit deadbolt square</p> |
|---|--|--|--------------------------------------|

keyless lock non electric



7940S non electric keyless entrance lock

electronic + keyless locks

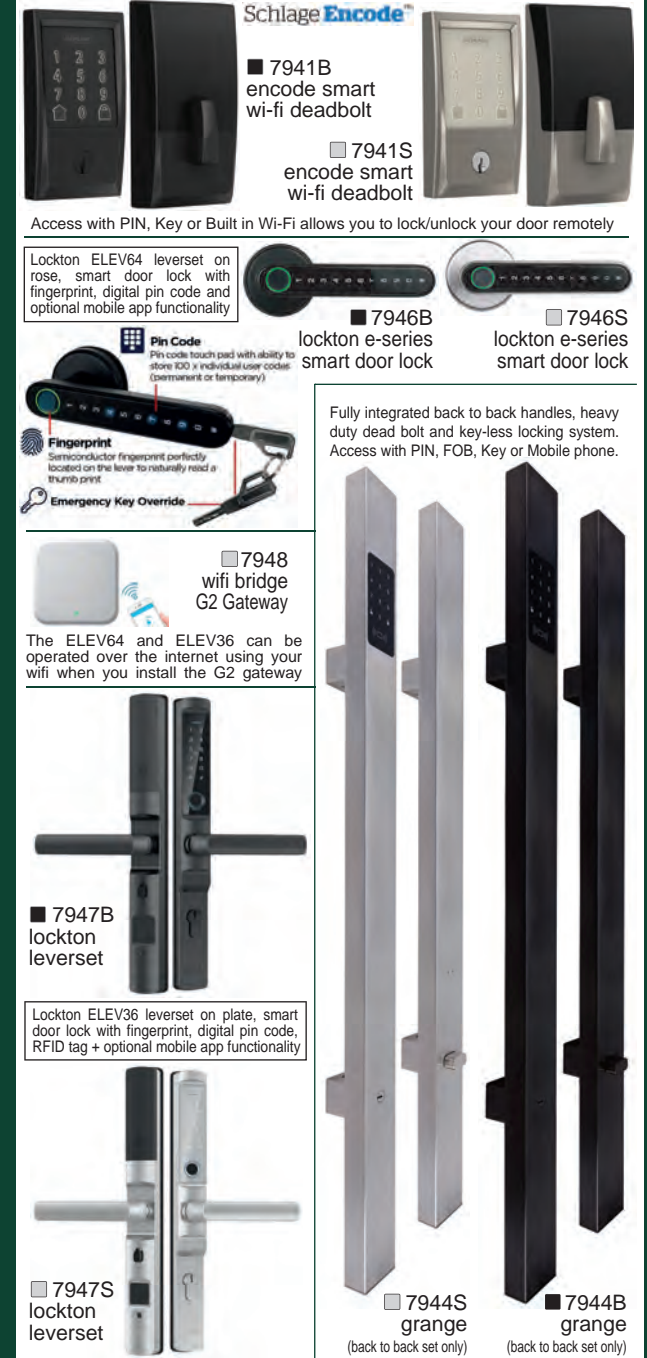

Schlage Encode™

7941B encode smart wi-fi deadbolt

7941S encode smart wi-fi deadbolt

Access with PIN, Key or Built in Wi-Fi allows you to lock/unlock your door remotely

Lockton ELEV64 leverset on rose, smart door lock with fingerprint, digital pin code and optional mobile app functionality

Pin Code
Pin code touch pad with ability to store 100 individual user codes (Permanent or temporary)

7946B lockton e-series smart door lock

7946S lockton e-series smart door lock

Fingerprint
Semiconductor fingerprint perfectly located on the lever to naturally read a thumb print

Emergency Key Override

7948 wifi bridge G2 Gateway

The ELEV64 and ELEV36 can be operated over the internet using your wifi when you install the G2 gateway

7947B lockton leverset

Lockton ELEV36 leverset on plate, smart door lock with fingerprint, digital pin code, RFID tag + optional mobile app functionality

7947S lockton leverset

7944S grange (back to back set only)

7944B grange (back to back set only)

door hardware

woodworkers barrel + flush bolts

190mm door flush bolts

window flush bolts

barrel + flush bolts

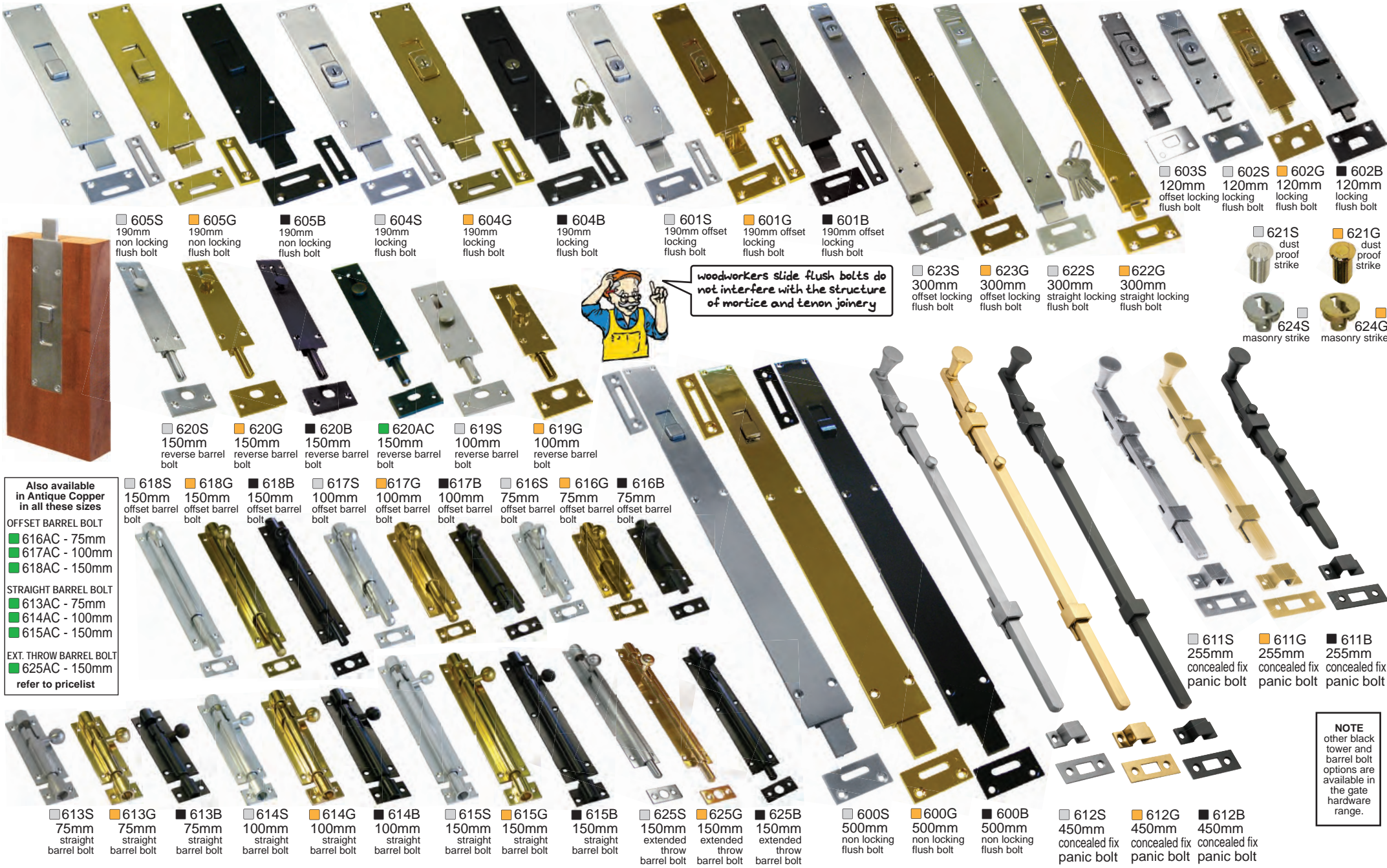

- 605S 190mm non locking flush bolt
- 605G 190mm non locking flush bolt
- 605B 190mm non locking flush bolt
- 604S 190mm locking flush bolt
- 604G 190mm locking flush bolt
- 604B 190mm locking flush bolt
- 601S 190mm offset locking flush bolt
- 601G 190mm offset locking flush bolt
- 601B 190mm offset locking flush bolt
- 623S 300mm offset locking flush bolt
- 623G 300mm offset locking flush bolt
- 622S 300mm straight locking flush bolt
- 622G 300mm straight locking flush bolt
- 621S dust proof strike
- 621G dust proof strike
- 624S masonry strike
- 624G masonry strike

- 620S 150mm reverse barrel bolt
- 620G 150mm reverse barrel bolt
- 620B 150mm reverse barrel bolt
- 620AC 150mm reverse barrel bolt
- 619S 100mm reverse barrel bolt
- 619G 100mm reverse barrel bolt
- 618S 150mm offset barrel bolt
- 618G 150mm offset barrel bolt
- 618B 150mm offset barrel bolt
- 617S 100mm offset barrel bolt
- 617G 100mm offset barrel bolt
- 617B 100mm offset barrel bolt
- 616S 75mm offset barrel bolt
- 616G 75mm offset barrel bolt
- 616B 75mm offset barrel bolt

- Also available in Antique Copper in all these sizes
- OFFSET BARREL BOLT**
- 616AC - 75mm
 - 617AC - 100mm
 - 618AC - 150mm
- STRAIGHT BARREL BOLT**
- 613AC - 75mm
 - 614AC - 100mm
 - 615AC - 150mm
- EXT. THROW BARREL BOLT**
- 625AC - 150mm
- refer to pricelist

- 613S 75mm straight barrel bolt
- 613G 75mm straight barrel bolt
- 613B 75mm straight barrel bolt
- 614S 100mm straight barrel bolt
- 614G 100mm straight barrel bolt
- 614B 100mm straight barrel bolt
- 615S 150mm straight barrel bolt
- 615G 150mm straight barrel bolt
- 615B 150mm straight barrel bolt
- 625S 150mm extended throw barrel bolt
- 625G 150mm extended throw barrel bolt
- 625B 150mm extended throw barrel bolt
- 600S 500mm non locking flush bolt
- 600G 500mm non locking flush bolt
- 600B 500mm non locking flush bolt
- 611S 255mm concealed fix panic bolt
- 611G 255mm concealed fix panic bolt
- 611B 255mm concealed fix panic bolt
- 612S 450mm concealed fix panic bolt
- 612G 450mm concealed fix panic bolt
- 612B 450mm concealed fix panic bolt

NOTE
other black tower and barrel bolt options are available in the gate hardware range.

refer to item code in current hardware pricelist for costings

woodworkers door accessories

router bits

DO NOT USE lever arch flush bolts

WARNING

Woodworkers does not sell or recommend lever arch flush bolts because they require a large concealed back swing which severs the tenons that hold the door together.

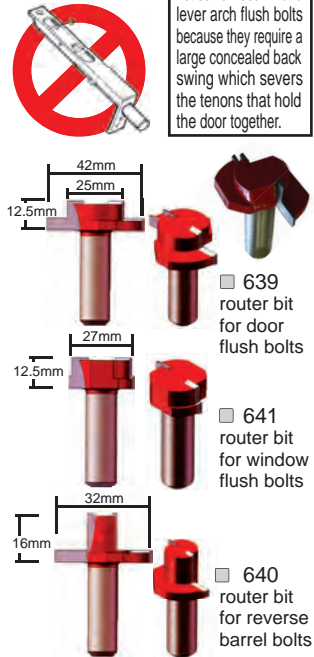

- 639 router bit for door flush bolts
- 641 router bit for window flush bolts
- 640 router bit for reverse barrel bolts

door stops + catches



- 588S door gripper catch total offset 85mm
- 588G door gripper catch total offset 85mm
- 539S half moon stop
- 539G half moon stop
- 539B half moon stop
- 578S concealed fix magnets 22mm diam
- 541G heavy duty roller catch
- 537S wall mount magnetic stop total offset 90mm
- 537G wall mount magnetic stop total offset 90mm
- 537B wall mount magnetic stop total offset 90mm
- 537AC wall mount magnetic stop total offset 90mm
- 586S bifold magnetic stop 40mm diam
- 586G bifold magnetic stop 40mm diam
- 541S heavy duty roller catch
- 538S floor mounted magnetic stop height 75mm
- 538G floor mount magnetic stop height 75mm
- 538B floor mount magnetic stop height 75mm
- 589G sparrows beak door catch total offset 85mm
- 540S light duty roller catch
- 540G light duty roller catch
- 541B heavy duty roller catch
- 536S suction door stop
- 536G suction door stop
- 589S sparrows beak door catch total offset 85mm
- 587S toe operated door stop 130mm
- 587G toe operated door stop 130mm
- 577G door guard

cabin hooks



- 535S silent pattern cabin hook 150mm
- 534S silent pattern cabin hook 100mm
- 534G silent pattern cabin hook 100mm
- 535G silent pattern cabin hook 150mm
- 534B silent pattern cabin hook 100mm
- 535B silent pattern cabin hook 150mm
- 534AC silent pattern cabin hook 100mm
- 535AC silent pattern cabin hook 150mm
- 594B traditional cabin hook 120mm

rack bolts



- 610G rack bolt (while stock lasts)

flush pulls

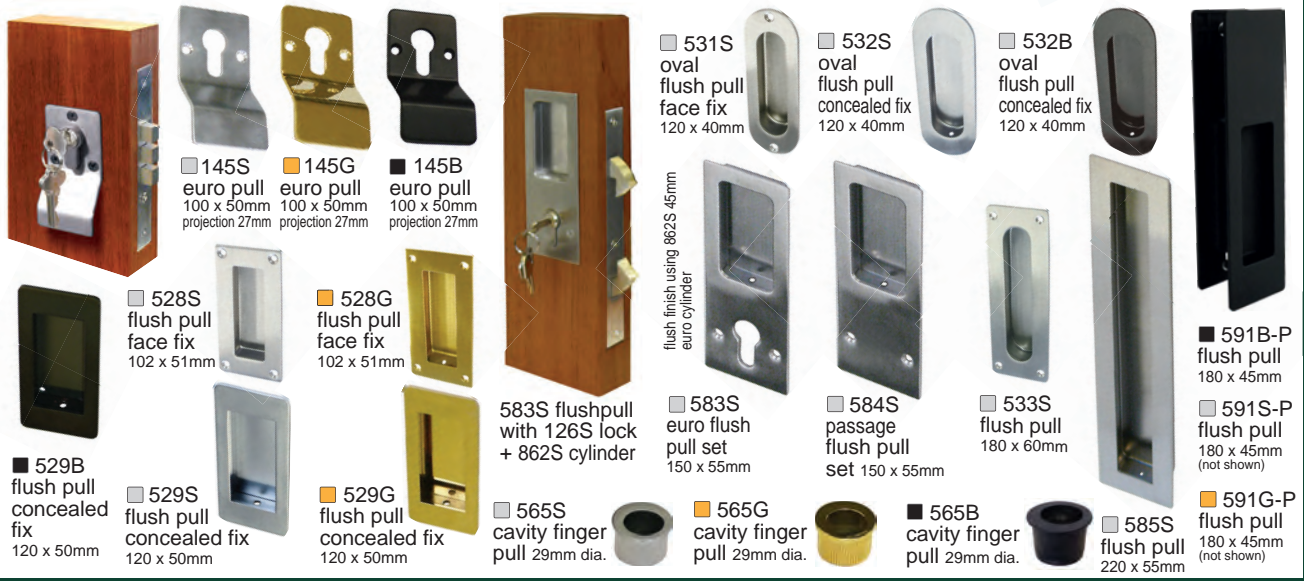

- 531S oval flush pull face fix 120 x 40mm
- 532S oval flush pull concealed fix 120 x 40mm
- 532B oval flush pull concealed fix 120 x 40mm
- 145S euro pull 100 x 50mm projection 27mm
- 145G euro pull 100 x 50mm projection 27mm
- 145B euro pull 100 x 50mm projection 27mm
- 528S flush pull face fix 102 x 51mm
- 528G flush pull face fix 102 x 51mm
- 529B flush pull concealed fix 120 x 50mm
- 529S flush pull concealed fix 120 x 50mm
- 529G flush pull concealed fix 120 x 50mm
- 583S flushpull with 126S lock + 862S cylinder
- 583S euro flush pull set 150 x 55mm
- 584S passage flush pull set 150 x 55mm
- 533S flush pull 180 x 60mm
- 565S cavity finger pull 29mm dia.
- 565G cavity finger pull 29mm dia.
- 565B cavity finger pull 29mm dia.
- 585S flush pull 220 x 55mm
- 591B-P flush pull 180 x 45mm
- 591S-P flush pull 180 x 45mm (not shown)
- 591G-P flush pull 180 x 45mm (not shown)

french door catches



- 598S french door square end fastener
- 500S french door teardrop fastener
- 598G french door square end fastener
- 500G french door teardrop fastener
- 598B french door square end fastener
- 500B french door teardrop fastener
- 500AC also available

refer to item code in current hardware pricelist for costings

door accessories

woodworkers door accessories

door accessories

studs + door decorators

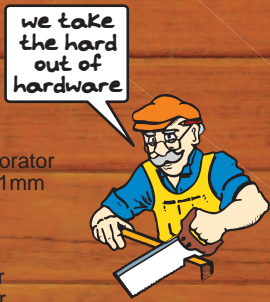

mock hinges + motifs

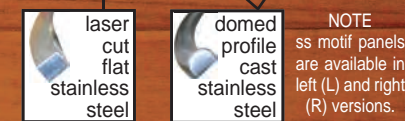
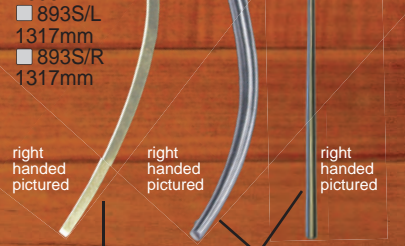
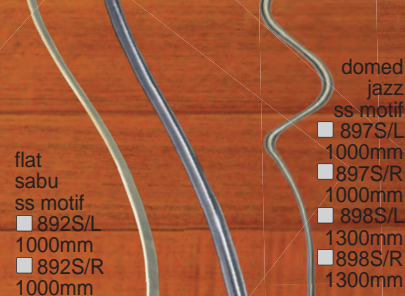

NOTE ss motif panels are available in left (L) and right (R) versions.

knobs + knockers



bells



centre pulls



sliding door



pulls



refer to item code in current hardware pricelist for costings

woodworkers gate hardware

gate hardware

cavity units



pushes

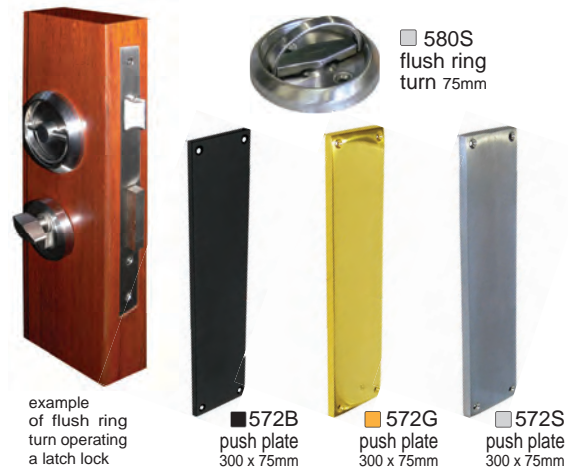

gate hardware



refer to item code in current hardware pricelist for costings

woodworkers pivot + slider hardware

light weight sliding hardware - 60kg

Brio

7009
sold in 2 and 3m lengths
BRIO SINGLE RUN 60 PACK
TOP HUNG SLIDING DOORS

- max height - 2400mm
- max width - 1500mm
- max weight : 60kg/door
- min door thickness - 24mm
- internal use only

suitable for a single door or for two doors on a bi-parting install doors may slide in one or both directions

single door kit comprises

- 2 hangers
- 2 door stops
- 1 guide
- spanner + screws

2m or 3m track lengths available

60 profile top track 31(w) x 30mm(h)

spanner

door stops

7019 pelmet

7007 bracket

NOT PART OF THE KIT

7026 soft close

pivots + closers

7901S slimline parallel arm door closer

7904S head reinforcing option for transom mounted hydraulic closer

7905B narrow pivot arm option for 40mm doors

7903 pivot door hydraulic transom closer

7906 floor mounted pivot closer with cover plate and bottom arm

7908S non hydraulic pivot bottom assembly

7909 concealed spring action door closer 150mm

7907S non hydraulic pivot top assembly

also requires 7907S

also requires 7907S

DORMA

surface mount top hung sliding hardware - 120kg

7040
sold in 2 and 3m lengths
For internal use only
Panels can slide to one or both sides
BRIO QUICK RUN 120

- max height - 3000mm
- max panel width - 75% of height
- max weight - 120kg
- door thickness - min 28mm
- clearance: 25mm ± 5mm

single door kit comprises

- top track 120F
- 2 x hangers
- 2 x clip stops
- 1 x nylon saw cut guide

120 profile top track 41(w) x 30mm(h)

clip stop

hanger

saw cut guide

7012 aluminium sleeve for poly track 25(w) x 23mm(h)

7013 poly track 21(w) x 20mm(h)

7022 bearing guide

7025 adjustable architrave guide

7005 single track 250kg bracket

7027 soft close

NOT PART OF THE KIT

zero clearance top hung sliding hardware - 120kg

7041
sold in 2 and 3m lengths
For internal use only
Panels can slide to one or both sides
BRIO QUICK RUN 120

- max height - 3000mm
- max panel width - 75% of height
- max weight - 120kg
- door thickness - min 32mm
- clearance: 3-5mm without soft close
- clearance: 7-13mm soft close

single door kit comprises

- top track 120F
- 2 x hangers
- 2 x clip stops
- 1 x nylon saw cut guide

120 profile top track 41(w) x 30mm(h)

clip stop

hanger

saw cut guide

7022 bearing guide

7025 adjustable architrave guide

7005 single track 250kg bracket

7027 soft close

top hung sliding hardware - 180kg

7008
sold in 2, 3, 4 and 6m lengths
BRIO SINGLE RUN 180 TOP HUNG HEAVY DUTY SLIDING DOORS

- max height - 3000mm
- max width - 2500mm
- max weight - 180kg
- door thickness - 35 - 48mm

for internal and external use for ease of operation, suitable for a single door or for two doors on a bi-parting install doors may slide in one or both directions

door kit comprises

- relevant length of top and bottom tracks
- 2 hangers
- 2 door stops
- 2 guides

top hanger

door stop

7011 180 profile top track 47(w) x 45mm(h)

7012 aluminium sleeve for poly track 25(w) x 23mm(h)

7013 poly track 21(w) x 20mm(h)

7005 single track 250kg bracket

7006 double track 250kg bracket

7025 adjustable architrave guide

NOT PART OF THE KIT

cavity unit

7950 wall cavity sliding unit

Frame construction will vary with size selected

bottom roller sliding hardware

max height - 2700mm
max width - 2400mm
max weight - 120kg
door thickness - min 40mm

7001 adjustable sliding bottom roller

7000 black top track guide

7003 sliding top glide 25 x 25 x 3mm

7004 sliding bottom track 20(w) x 6.5mm(h)

7002 913DBA heavy duty double bogey adjustable roller

BRIO TIMBEROLL 200 HEAVY DUTY BOTTOM ROLLER SLIDING DOORS

- max height - 3000mm
- max width - 3000mm
- max weight - 200kg
- door thickness - 38 - 48mm

internal and external use. suitable for any number of doors to cover the opening on single or multiple tracks. doors may slide in one or both directions

NOTE : requires (2) two guides and (2) rollers per door. Top and bottom track comes in 6m lengths. Sold in 2,3,4 and 6m lengths only.

refer to item code in current hardware pricelist for costings

woodworkers bifold hardware

internal bifolds

7010
sold in 2, 3, 4 and 6m lengths
Brio
 BRIO SHUTTER FOLD 25
 BIFOLD DOORS
 • max height : 2400mm
 • max width : 900mm
 • max weight : 25kg/door
 • door thickness : min 35mm
 • internal use only
 suitable for up to 6 leaves
 pivoted to each side of an
 opening available in
 • 2 door, 4 door + 6 door packs
 • 2 door no channel pack

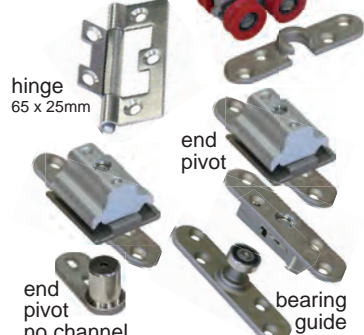

7014
 100 profile top track
 41(w) x 30mm(h)
7012
 aluminium sleeve
 for poly track
 25(w) x 23mm(h)
7013
 poly track
 21(w) x 20mm(h)

398
**pleated screen
 repair kit**



buy only the best bifold
 hardware & you'll never
 have any trouble

how to restring
 brio pleated screen
 video

door overhead track bifold hardware



7011
 180 profile
 top track
 47(w) x 45mm(h)
7012
 aluminium
 sleeve for
 poly track
 25(w) x 23mm(h)
7013
 poly track
 21(w) x 20mm(h)
7305S
 end hanger
 non morticed
 top
7305G
 end hanger
 non morticed
 top
7301S
 pivot top
7301G
 pivot top
7301B
 pivot top
7302S
 intermediate
 hanger top
7302G
 intermediate
 hanger top
7302B
 intermediate
 hanger top
7303S
 pivot
 anchor
 bottom
7303G
 pivot
 anchor
 bottom
7303B
 pivot
 anchor
 bottom
7304S
 intermediate
 guide
 bottom
7304G
 intermediate
 guide
 bottom
7304B
 intermediate
 guide
 bottom
7307S
 jamb pivot
 bottom
7307G
 jamb pivot
 bottom
7307B
 jamb pivot
 bottom
7306S
 end guide
 non morticed
 bottom
7306G
 end guide
 non morticed
 bottom
7306B
 end guide
 non morticed
 bottom
7120S
 offset hinge
7120G
 offset hinge
7120B
 offset hinge
7121S
 intermediate
 hinge
7121G
 intermediate
 hinge
7121B
 intermediate
 hinge
7122S
 intermediate
 hinge handle
7122G
 intermediate
 hinge handle
7122B
 intermediate
 hinge handle
7123S
 offset hinge
 handle
7123G
 offset hinge
 handle
7123B
 offset hinge
 handle
7124S
 butt hinge
 handle
7124G
 butt hinge
 handle

7401S
 see pricelist for other options
 BRIO 286 DUAL POINT
 LOCK SYSTEM
 • panel thickness 38mm - 44mm
 • max panel height 2.9m
 • throw of bolt 25 x 5mm SS bar
 • 45mm backset
 • suits intermediate or end
 hanging doors
 • locking or non locking

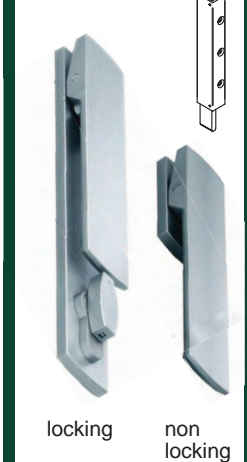
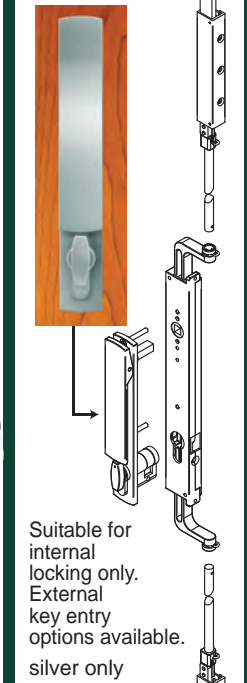

Suitable for
 internal
 locking only.
 External
 key entry
 options available.
 silver only

Brio
 NOTE :
 bifold hardware
 component designs
 may change at
 manufacturer's
 discretion

bifold hardware

woodworkers window hardware

friction stays

329S (pictured) 300mm with restrictor - 30kg

stainless casement or awning friction stay

- 387S 203mm - 12kgs
- 388S 414mm - 30kgs
- 389S 503mm awning only - 24kgs
- 390S 602mm awning only - 35kgs

HEAVY DUTY

- 391S 263mm - 34kgs
- 392S 414mm - 63kgs
- 393S 567mm - 74kgs
- 394S 683mm - 90kgs awning only

how to install a casement sash video



whitco friction stays pair

- 395Z 200mm - 10kgs
- 396Z 300mm - 11.8kgs

casement + shutter restraints

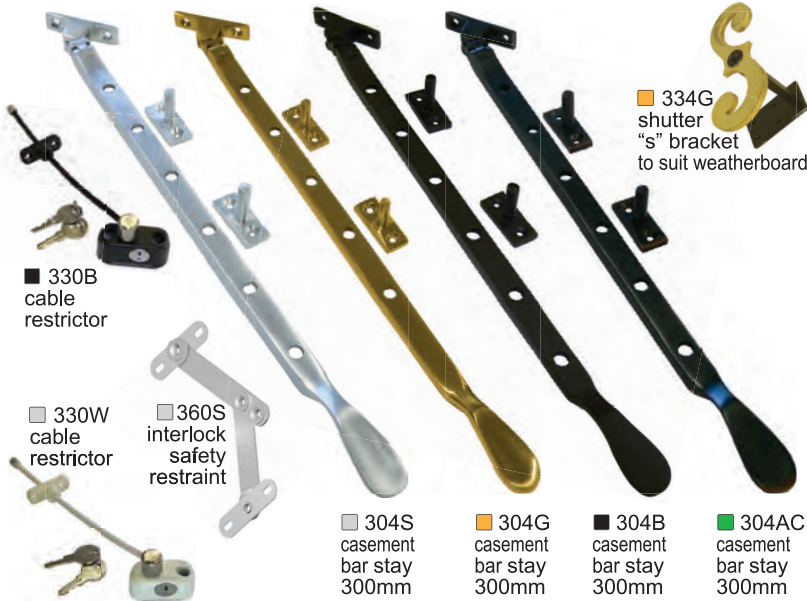

330B cable restrictor

330W cable restrictor

360S interlock safety restraint

304S casement bar stay 300mm

304G casement bar stay 300mm

304B casement bar stay 300mm

304AC casement bar stay 300mm

334G shutter "s" bracket to suit weatherboard

305S drop down telescopic stay (pictured)

306S screw down telescopic stay

305G drop down telescopic stay (pictured)

306G screw down telescopic stay

305AC drop down telescopic stay

306AC screw down telescopic stay (pictured)

305B black drop down telescopic stay available

324S quad stay

324G quad stay

324B quad stay

324AC quad stay

fanlight hardware



312S fanlight catch

312G fanlight catch

312B fanlight catch

327S map rod while stocks last

327G map rod

327B map rod while stocks last

locking chain winders

Whitco



307S locking chain winder



307BRW locking chain winder



307B locking chain winder



307W locking chain winder

key lockable catches



316S locking casement lever universal

316G locking casement lever universal

316B locking casement lever universal

318W locking casement lever left hand

326AC left hand

locking casement lever on side stile

locking casement lever on bottom rail

317W locking casement lever right hand

locking teardrop casement fastener

non-keyed catches

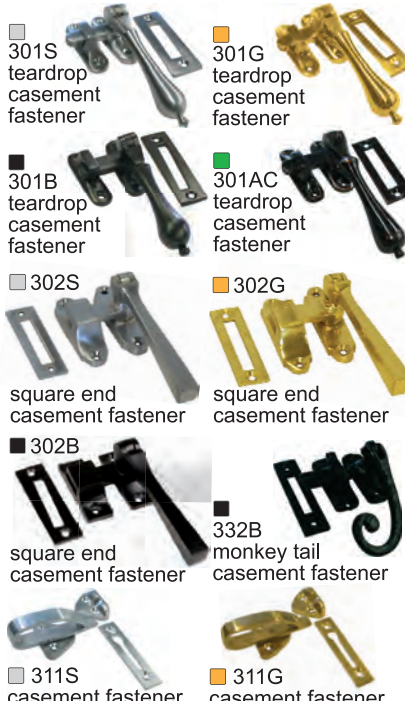

301S teardrop casement fastener

301B teardrop casement fastener

302S square end casement fastener

302B square end casement fastener

311S casement fastener

301G teardrop casement fastener

301AC teardrop casement fastener

302G square end casement fastener

302B monkey tail casement fastener

311G casement fastener

cockspurs



303S window spur catch

303G window spur catch

303B window spur catch

303AC window spur catch

335S window spur catch contemporary

handles

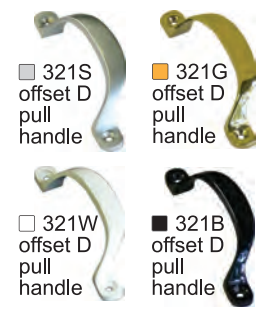

321S offset D pull handle

321W offset D pull handle

320S push lock

320W push lock

321G offset D pull handle

321B offset D pull handle

320B push lock

push locks



320S push lock

320W push lock

Whitco



341S hook hinge galvanised

313S fanlight cleat 75mm

313G fanlight cleat 75mm

314G fanlight pivot

314S fanlight pivot

321G offset D pull handle

321B offset D pull handle

313B fanlight cleat 75mm

314B fanlight pivot

window kits

fitch locks



sash locks + holds



lifts



sliding window hardware



gas struts



CASEMENT WINDOW KIT



CASEMENT WINDOW KIT - SILVER

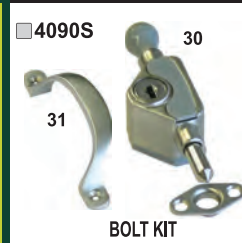

CASEMENT WINDOW KIT - GOLD

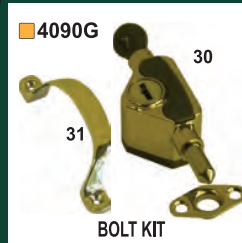

CASEMENT WINDOW KIT - BLACK



CASEMENT WINDOW KIT - WHITE



DOUBLE HUNG WINDOW KIT



DOUBLE HUNG WINDOW KIT - SILVER

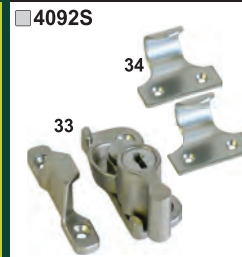

DOUBLE HUNG WINDOW KIT - GOLD



DOUBLE HUNG WINDOW KIT - BLACK



DOUBLE HUNG WINDOW KIT - WHITE



HOPPER WINDOW KIT

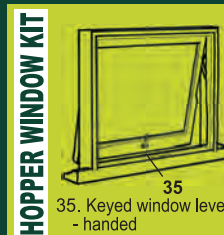

HOPPER WINDOW KIT - SILVER



HOPPER WINDOW KIT - GOLD



HOPPER WINDOW KIT - BLACK



HOPPER WINDOW KIT - WHITE

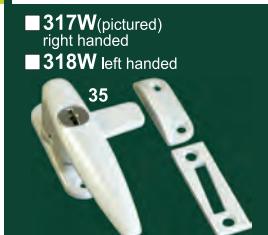

SLIDING WINDOW KIT



SLIDING WINDOW KIT - SILVER



SLIDING WINDOW KIT - GOLD



SLIDING WINDOW KIT - BLACK



SLIDING WINDOW KIT - WHITE



woodworkers louvre galleries + accessories

woodworkers louvre galleries + accessories

louvre galleries

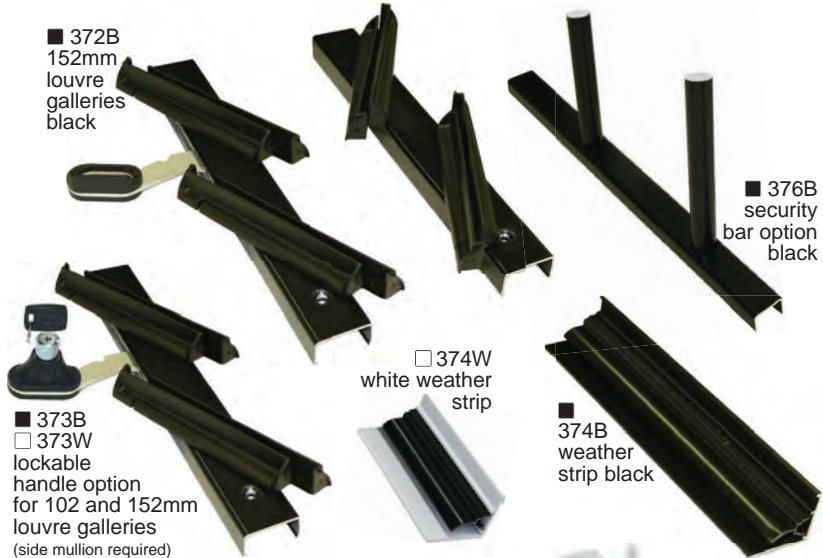

| number of blades | gallery height | handle quantity |
|------------------|----------------|-----------------|
| 3 | 292mm | 1 |
| 4 | 381mm | 1 |
| 5 | 470mm | 1 |
| 6 | 559mm | 1 |
| 7 | 648mm | 1 |
| 8 | 737mm | 2 |
| 9 | 826mm | 2 |
| 10 | 914mm | 2 |
| 11 | 1003mm | 2 |
| 12 | 1092mm | 2 |
| 13 | 1181mm | 2 |
| 14 | 1270mm | 2 |
| 15 | 1359mm | 3 |
| 16 | 1448mm | 3 |
| 17 | 1537mm | 3 |
| 18 | 1626mm | 3 |
| 19 | 1715mm | 3 |
| 20 | 1803mm | 3 |
| 21 | 1892mm | 3 |
| 22 | 1981mm | 4 |
| 23 | 2070mm | 4 |
| 24 | 2159mm | 4 |
| 25 | 2248mm | 4 |
| 26 | 2337mm | 4 |
| 27 | 2426mm | 4 |
| 28 | 2515mm | 4 |
| 29 | 2604mm | 5 |
| 30 | 2693mm | 5 |

add 6mm to heights for weatherstrip

372B 372W 152mm adjustable louvre galleries

| number of blades | gallery height | handle quantity |
|------------------|----------------|-----------------|
| 2 | 305mm | 1 |
| 3 | 445mm | 1 |
| 4 | 584mm | 1 |
| 5 | 724mm | 1 |
| 6 | 864mm | 1 |
| 7 | 1003mm | 2 |
| 8 | 1143mm | 2 |
| 9 | 1283mm | 2 |
| 10 | 1422mm | 2 |
| 11 | 1562mm | 2 |
| 12 | 1702mm | 2 |
| 13 | 1842mm | 3 |
| 14 | 1981mm | 3 |
| 15 | 2121mm | 3 |
| 16 | 2261mm | 3 |
| 17 | 2401mm | 3 |
| 18 | 2540mm | 3 |
| 19 | 2680mm | 4 |
| 20 | 2820mm | 4 |

add 6mm to heights for weatherstrip

NOTES

- All controls are on the left hand gallery as standard. Right hand controls available to order.
- Maximum 7 blades per control on 102mm galleries and 6 blades on 152mm galleries.
- Key locking option available at additional cost.
- Glass louvre galleries take 152 x 6mm or 102 x 6mm polished edge glass blades.
- Timber louvre galleries are available that accept 102 x 13.5mm or 152 x 13.5mm profile timber blades.
- Standard colours are black, pearl white + silver anodised.

spirals + pulleys



| spiral number | body length | spiral number | body length |
|---------------|-------------|---------------|-------------|
| 361 - 20 | 320mm | 361 - 48 | 725mm |
| 361 - 22 | 345mm | 361 - 410 | 750mm |
| 361 - 26 | 395mm | 361 - 50 | 775mm |
| 361 - 28 | 420mm | 361 - 52 | 800mm |
| 361 - 30 | 470mm | 361 - 54 | 830mm |
| 361 - 32 | 495mm | 361 - 56 | 855mm |
| 361 - 34 | 525mm | 361 - 58 | 880mm |
| 361 - 36 | 550mm | 361 - 510 | 905mm |
| 361 - 38 | 575mm | 361 - 60 | 930mm |
| 361 - 310 | 600mm | 361 - 62 | 955mm |
| 361 - 40 | 625mm | 361 - 64 | 980mm |
| 361 - 42 | 650mm | 361 - 68 | 1030mm |
| 361 - 44 | 675mm | 361 - 70 | 1085mm |
| 361 - 46 | 700mm | 361 - 72 | 1110mm |

Heavy duty Schlegel spiral balances are also available in white and black which are custom made for specific weights. They are POA and have extended lead times

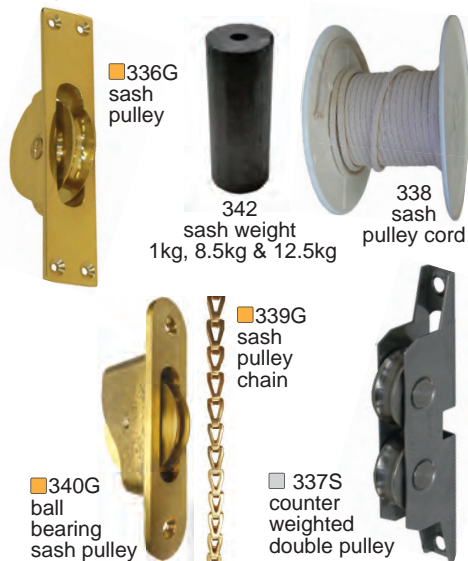

glazing accessories



other stuff



344S window hood privacy screen strut stainless steel 425mm



359 door lifter allows hands free adjustment of door height when fitting hinges

pet doors

DOG DOORS FOR INSTALLATION IN SOLID DOORS



two way locking magnetic close



- 345W small flap size 170(W) x 240mm(H)
- 346W medium flap size 225(W) x 290mm(H)
- 347W large flap size 295(W) x 425mm(H)
- 346B medium flap size 225(W) x 290mm(H)
- 347 large flap size 295(W) x 425mm(H)

PET DOOR FOR INSTALLATION IN GLASS

clear polycarbonate with weatherseal and 4 way locking system.



cat door

348 overall size 290mm flap size 190(W) x 190mm(H) also suitable for small dogs up to 9kg

dog door

349 overall size 435mm flap size 290(W) x 290mm(H) semi large dogs (golden retriever) up to 18kg

vents

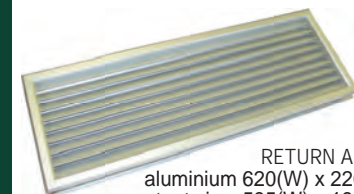

350S RETURN AIR VENT aluminium 620(W) x 220mm(H) cutout size: 595(W) x 195mm(H) available in clear anodized and 16 powder coat colours (quantity restrictions apply)

woodworkers stealshield + timber accessories

seals

seal extended
seal retracted

7922S auto extending door seal

7921 3 fin under door seal 920mm

7920 3 fin under door seal 1200mm

7926TB pivot brush seal

7923BRW bifold z-seal

7923W bifold z-seal

7924BRW window block seal

7924W window block seal

7925B undersash mohair strip



stealshield screens

top hinge detail

377T timber grain d/hung top hinged stealshield

bottom pushlock detail

new product

stock stealshield panels for stock double hung windows available in timber grain and white.

height x width

- 2074 x 598
- 2074 x 758
- 1761 x 598
- 1761 x 898
- 1461 x 448
- 1461 x 598
- 1461 x 748
- 1461 x 898
- 1161 x 448
- 1161 x 598
- 1161 x 748
- 1161 x 898
- 1161 x 1198
- 961 x 598
- 961 x 748
- 961 x 898

378T safebreeze ventilation door panel with stealshield security mesh and openable, clear glazed, timber grain sash aperture sizes available

- 1048 x 224mm
- 1639 x 169mm

security isn't pricey... it's priceless

STEALSHIELD WINDOW PROTECTION

Stealshield panels provide affordable intruder, insect and bushfire protection and have the convenience of being easily openable for painting, cleaning and escape during emergencies. Stealshields are constructed of woven powdercoated stainless steel mesh with apertures less than 2mm to comply with bushfire regulations, encased in timber grain or white trim to blend unobtrusively with timber joinery.

377W white double hung top hinged stealshield

insect screens

380BZ bronze insect screen mesh

381B black anodized aluminium insect screen mesh

382B black fiberglass micro insect screen mesh

383B black heavy duty pet proof pvc insect screen mesh

384CL clear insect screen toggle 10mm offset

379B black fiberglass insect screen mesh

385T 385W stock fiberglass mesh screens for d/hung windows. white + timber grain available

| height x width | height x width | height x width |
|----------------|----------------|----------------|
| 2057 x 713 | 1441 x 553 | 1141 x 403 |
| 2057 x 553 | 1441 x 403 | 941 x 853 |
| 1741 x 853 | 1141 x 1153 | 941 x 703 |
| 1741 x 553 | 1141 x 853 | 941 x 553 |
| 1441 x 853 | 1141 x 703 | |
| 1441 x 703 | 1141 x 553 | |

timber finials & corbels

RF2 RF3

70 x 70 ROOF FINIALS

650 mm our turnery is made in durable hardwood
760 mm customised designs available
950 mm

Ball A 75 x 75

Acorn B 100 x 100

Crown 2 100 x 100

Crown 3 100 x 100

Stock timber balls for external use are made in durable hardwood

FP7 clear grade pine 63 x 34

cedar corbel

T16 320 X 100 X 75

post caps

C3 C4

C7 C8

decorative finial caps for metal or timber post

fit on over

- 90 x 90mm
- 100 x 100mm
- 120 x 120mm
- 125 x 125mm
- 150 x 150mm

they are sold in a mill finish (aluminium) ready to be painted Powder coated POA

refer to item code in current hardware pricelist for costings

woodworkers stealshield + timber accessories

woodworkers finishes

woodworkers finishes



5 GOOD REASONS WHY YOU SHOULD USE SIKKENS OIL BASED COATINGS

- As a natural oil-based coating it nourishes the timber while at the same time allowing it to breathe.
- It is very easy to apply and can easily be removed from glass etc when accidents occur.
- It is equally easy to re-coat over time without the need for the complicated etching required with plastic acrylic coatings.
- It has excellent longevity
- It 'lubricates' movement of the joinery items that need to slide against each other (eg double hung windows) rather than acrylic coatings which tend to stick together.

SIKKENS ON CEDAR

SIKKENS ON PINE

077 pine



006 light oak



009 dark oak



010 walnut*

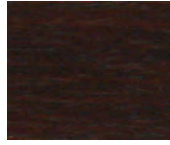

045 mahogany

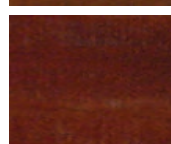
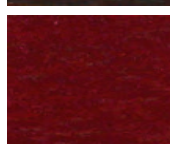

048 rosewood

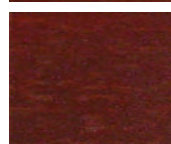
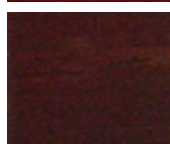

085 teak

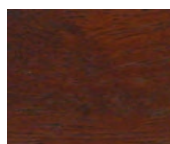

813 silver grey

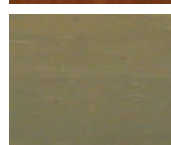
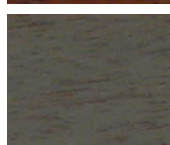

020 ebony*

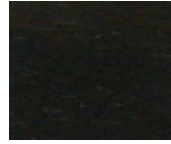

finishing products

sikkens



362
CETOL HLS
Water repellent, penetrating, low build transparent wood stain used as a base coat under cetol Filter 7 Plus, TGL Gloss Plus and Deck Plus.
1L, 4L + 20L cans



366
CETOL TGL PLUS
High gloss oil based finish for exterior doors applied over Cetol HLS base coat. Durable, flexible and completely clear
1L cans



363
CETOL FILTER 7 PLUS
Flexible medium build transparent satin top coat with UV filters. Designed as two coat finishing over Cetol HLS.
1L, 4L + 20L cans



368
WHITE UNDERCOAT FAST DRYING
Quick drying oil based undercoat that sands to a smooth base for enamel top coats
1L, 4L + 10L cans

we recommend these products because we know they work!



how to finish your joinery video



365
CETOL TSI SATIN PLUS
Transparent oil based finish for interior use only. Non toxic with good resistance to wear. Seal, top coat and stain in a single can.
1L + 2.5L cans



352
INOX
stainless steel lubricant spray
100gm +300gm

*Dark colours are not recommended for external use. Refer FAQ 3 for warranty conditions

woodworkers videos

product videos



entry doors

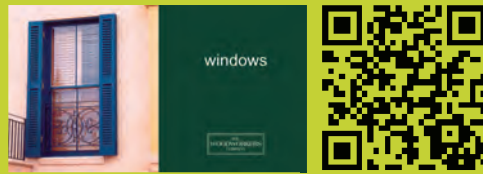

windows



bifolds french doors and sliders



plantation shutters



video brio pleated insect screens



restoration products



offshore joinery manufacture



repairing dints and finishing timber

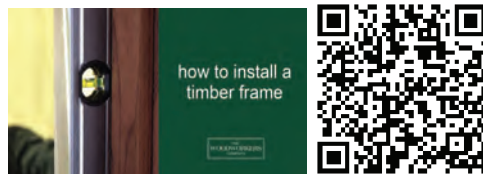

how to install a timber frame

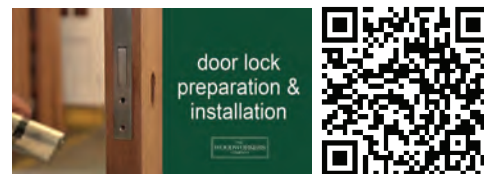

door lock preparation & installation

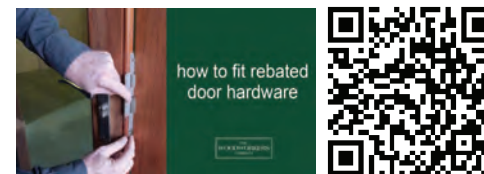

how to fit rebated door hardware



video how to assemble & install a flat pack bifold kit

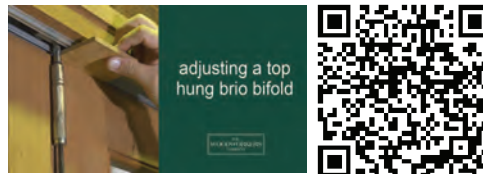

adjusting a top hung brio bifold



video restringing a brio insect screen



how to measure for plantation shutters

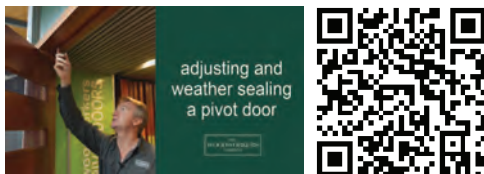

adjusting and weather sealing a pivot door

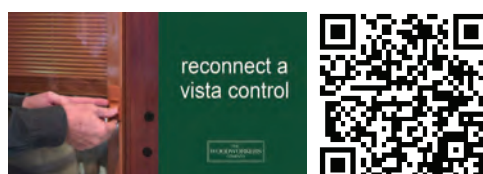

reconnect a vista control

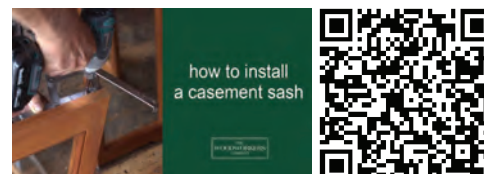

how to install a casement sash

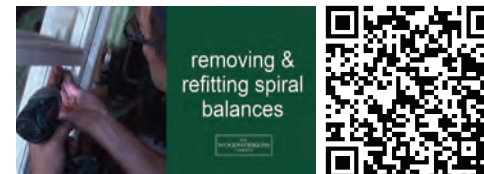

removing & refitting spiral balances



installing a window hood & privacy screen

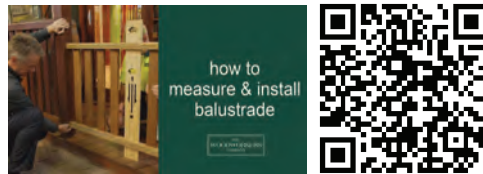

how to measure & install balustrade



Woodworkers have produced numerous videos aimed at explaining our products and providing practical instructions on common issues relating to their installation and maintenance. Our video range continues to expand and augments our extensive website FAQ section which focuses on product details and consumer queries. To access the videos you would need to have downloaded the QR code scanner application for your mobile device.

woodworkers videos

'how to' videos

Need more information or prices refer our FAQ sheets at www.woodworkers.com.au or entering WOODWORKERS COMPANY on for our 'how to' videos



Our website FAQ sheets explain most issues that relate to our products & provide current pricing.



VERSION 8.24

Queensland hardware pricelist

All prices are subject to change during the currency of this catalogue. Hardware and finish specifications were correct at the date of publication but may vary over time. Not all product will be held in stock at all times. Lead times may be required for non stocked items. Prices do not include keying alike, installation or delivery. A 15% restocking fee will apply to all stock orders returned for refund in merchantable condition. Product where original packaging is not intact is not returnable. All products bought in for specific orders are non refundable or returnable and payment is required in advance. Alternative non stock hardware products can be supplied by Woodworkers on a prepaid basis. All hardware has a 1 year mechanical warranty that does not extend to product finishes. Warranty details are on FAQ 9 at

woodworkers.com.au

BRISBANE
1095 Ipswich Rd
Moorooka 4105
☎ 07 3848 1383
F: 07 3892 1476

GOLD COAST
Warehouse Road
Southport 4215
☎ 07 5571 0088
F: 07 5571 0617

SUNCOAST
53 Wises Road
Maroochydore
☎ 07 5479 0999
F: 07 5479 0911

ALL PRICES INCLUDE GST

VERSION 8.24

FIXING LEGEND

Table with 2 columns: Fixing type (B/B, C/F, F/F, R/F, UNIV) and description (Back to back set, Concealed fix, Face fix, Rear fix, Universal fix).

FINISH LEGEND

Table with 2 columns: Finish code (Al, Anod, Blk, Brass, Brw, Brz, BSC, Clr, Cop, EB, FAB, FABlk, FABrz, FACop, FAS, FGP, Gal, Gold, MB, NP, OW, PB, Pc, PSS, PVD, RI, SC, Silver, SNP, SS, T, Wht, ZP) and description (Aluminium, Anodized, Black, Natural Brass, Brown, Bronze, Black Satin Chrome, Clear, Copper, Electro Brass, Faux Antique Brass, Faux Antique Black, Faux Antique Bronze, Faux Antique Copper, Faux Antique Silver, Faux Gold Plate, Galvanized, Gold look, Matt Black, Nickel Plate, Off White, Polished Brass, Powdercoat, Polished Stainless Steel, Non tarnishing PVD, Rusty Iron, Satin Chrome, Silver look, Satin Nickel Plate, Satin Stainless, Timber/Timbergrain, White, Zinc Plate).

MATERIALS LIST

Table with 2 columns: Material number (1-16) and description (Stainless Steel, Marine Grade 316 Stainless Steel, Cast Stainless Steel, Brass; Cast Brass; Forged Brass, Sheet Brass; Brass Wire, Cast Iron; Malleable Iron; Sheet Iron, Timber, Porcelain; Stone, Zinc Diecast, Sheet Steel; Mild Steel, Cast Steel, Andalusia 325 C:C, Andalusia 470 C:C, Antique Raj 470 C:C, Aqua Jazz 540 L/Hand C:C, Aqua Jazz 540 R/Hand C:C, Aqua Jazz 540 Copper L/Hand C:C, Aqua Jazz 540 Copper R/Hand C:C, Bangalow 300 C:C, Bangalow 400 C:C, Barcelona 680 Left Hand C:C).

Main hardware price list table with columns: Code, Description, Finish, Material, Price, Unit. Contains items like 1154B, 1154G, 1154S, etc.

Continuation of hardware price list table with columns: Code, Description, Fixing, Size, Finish, Material, Price, Unit. Contains items like 3001G/L, 3001S/L, etc.

Continuation of hardware price list table with columns: Code, Description, Fixing, Size, Finish, Material, Price, Unit. Contains items like 3009B/R, 3010S, 3010ST, etc.

hardware pricelist



VERSION 8.24

Table with columns: Code, Description, Fixing, Size, Finish, Material, Price, Unit. Contains a wide range of hardware items like handles, knobs, and door pulls.

Table with columns: Code, Description, Fixing, Size, Finish, Material, Price, Unit. Contains items like door handles, knobs, and door pulls.

Table with columns: Code, Description, Finish, Material, Price, Unit. Contains items like door handles, knobs, and door pulls.

FIXING LEGEND table with columns: Code, Description. Lists various fixing types like B/B, C/F, F/F, R/F, UNIV.

FINISH LEGEND table with columns: Code, Description. Lists various finishes like Al, Anod, Blk, Brass, Brw, Brz, BSC, Clr, Cop, EB, FAB, FABlk, FABrz, FACop, FAS, FGP, Gal, Gold, MB, NP, OW, PC, PSS, PVD, RI, SC, Silver, SNP, SS, T, Wht, ZP.

MATERIALS LIST table with columns: Code, Description. Lists various materials like 1, 2, 3, 4, 5, 6, 7, 8, 9, 10, 11, 12, 13, 14, 15, 16.

hardware pricelist

All prices are subject to change during the currency of this catalogue. Hardware and finish specifications were correct at the date of publication but may vary over time. Not all product will be held in stock at all times. Lead times may be required for non stocked items. Prices do not include keying alike, installation or delivery. A 15% restocking fee will apply to all stock orders returned for refund in merchantable condition. Product where original packaging is not intact is not returnable. All products bought in for specific orders are non refundable or returnable and payment is required in advance. Alternative non stock hardware products can be supplied by Woodworkers on a prepaid basis. All hardware has a 1 year mechanical warranty that does not extend to product finishes. Warranty details are on FAQ 9 at woodworkers.com.au

**ALL PRICES
INCLUDE
GST**

VERSION 8.24

FIXING LEGEND

| | |
|------|--|
| B/B | Back to back set |
| C/F | Concealed fix |
| F/F | Face fix |
| R/F | Rear fix |
| UNIV | Universal fix (face fix or back to back) |

FINISH LEGEND

| | |
|--------|--------------------------|
| Al | Aluminium |
| Anod | Anodized |
| Blk | Black |
| Brass | Natural Brass |
| Brw | Brown |
| Brc | Bronze |
| BSC | Black Satin Chrome |
| Clr | Clear |
| Cop | Copper |
| EB | Electro Brass |
| FAB | Faux Antique Brass |
| FABlk | Faux Antique Black |
| FABrz | Faux Antique Bronze |
| FACop | Faux Antique Copper |
| FAS | Faux Antique Silver |
| FGP | Faux Gold Plate |
| Gal | Galvanized |
| Gold | Gold look |
| MB | Matt Black |
| NP | Nickle Plate |
| OW | Off White |
| PB | Polished Brass |
| Pc | Powdercoat |
| PSS | Polished Stainless Steel |
| PVD | non tarnishing PVD |
| RI | Rusty Iron |
| SC | Satin Chrome |
| Silver | Silver look |
| SNP | Satin Nickle Plate |
| SS | Satin Stainless |
| T | Timber/Timbergrain |
| Wht | White |
| ZP | Zinc Plate |

MATERIALS LIST

| | |
|----|---------------------------------------|
| 1 | Stainless Steel |
| 2 | Marine Grade 316 Stainless Steel |
| 3 | Cast Stainless Steel |
| 4 | Brass; Cast Brass; Forged Brass |
| 5 | Sheet Brass; Brass Wire |
| 6 | Cast Iron; Malleable Iron; Sheet Iron |
| 7 | Timber |
| 8 | Porcelain; Stone |
| 9 | Zinc Diecast |
| 10 | Sheet Steel; Mild Steel |
| 11 | Carbon Steel |
| 12 | Acrylic; Polymer; PVC; Polycarbonate |
| 13 | Aluminium |
| 14 | Lead |
| 15 | Fibreglass |
| 16 | Other metals |

| Code | Description | Finish | Material | Price | Unit |
|------------|--|----------|----------|------------|-------|
| 7306G | End guide non morticed bottom | PVD Gold | 1 | \$133.00 | ea |
| 7306S | End guide non morticed bottom | SS | 1 | \$133.00 | ea |
| 7307B | Jamb pivot bottom | PVD Blk | 1 | \$99.00 | ea |
| 7307G | Jamb pivot bottom | PVD Gold | 1 | \$82.00 | ea |
| 7307S | Jamb pivot bottom | SS | 1 | \$82.00 | ea |
| # 7401S | Bifold dual point system - non locking - intermediate | SS | 1 | \$461.00 | ea |
| # 7402S | Bifold dual point system - locking - intermediate | SS | 1 | \$564.00 | ea |
| # 7403S | Bifold dual point system - non locking - end door | SS | 1 | \$416.00 | ea |
| # 7404S | Bifold dual point system - locking - end door | SS | 1 | \$518.00 | ea |
| 7901S | Slimline parallel arm door closer | SC | 9 | \$166.00 | ea |
| 7903-22 | Pivot door hydraulic transom closer | | 6 | \$477.00 | ea |
| 7904S | Head reinforcing plate for hydraulic closer | Al | 13 | \$92.00 | ea |
| 7905B | Narrow pivot arm option for 40 mm doors | Blk | 6 | \$57.00 | ea |
| # 7906 | Hydraulic floor mounted pivot closer, plate & arm | | 10 | \$1,505.00 | ea |
| # 7907S | Non hydraulic pivot top assembly | | 10 | \$286.00 | ea |
| # 7908S | Non hydraulic pivot bottom assembly | | 10 | \$99.00 | ea |
| # 7909 | Concealed spring action door closer | NP | 10 | \$96.00 | ea |
| 7920 | 3 fin under door seal 1200 mm | | 12 | \$31.00 | ea |
| 7921 | 3 fin under door seal 920 mm | | 12 | \$27.00 | ea |
| # 7922S-8 | Auto extending door seal 820 mm | Cl Anod | | \$178.00 | ea |
| # 7922S-9 | Auto extending door seal 920 mm | Cl Anod | | \$183.00 | ea |
| # 7922S-10 | Auto extending door seal 1070 mm | Cl Anod | | \$194.00 | ea |
| 7923BRW | Bifold z-seal | Brw | | \$12.00 | /l.m. |
| 7923W | Bifold z-seal | Wht | | \$12.00 | /l.m. |
| 7924BRW | Window block seal | Brw | | \$12.00 | /l.m. |
| 7924W | Window block seal | Wht | | \$12.00 | /l.m. |
| 7925B | Undersash mohair strip | | 12 | \$9.00 | /l.m. |
| 7926TB-12 | Pivot Brush Seal - 1200 mm | Timber | 7; 12 | \$46.00 | ea |
| 7926TB-15 | Pivot Brush Seal - 1500 mm | Timber | 7; 12 | \$57.00 | ea |
| # 7940S | Non electric keyless entrance lock | SC | 9 | \$541.00 | ea |
| # 7941B | Encode Smart Wi-fi Deadbolt | Blk | | \$587.00 | ea |
| # 7941S | Encode Smart Wi-fi Deadbolt | SC | | \$587.00 | ea |
| # 7944B | The Grange Digital 900 B-B | MB | 1 | \$1,142.00 | set |
| # 7944S | The Grange Digital 900 B-B | SS | 1 | \$1,142.00 | set |
| # 7946B | Smart Door Lock on Rose Black | MB | | \$337.00 | set |
| # 7946S | Smart Door Lock on Rose Silver | Silver | | \$337.00 | set |
| # 7947B | Smart Door Lock on Plate Black | MB | | \$572.00 | set |
| # 7947S | Smart Door Lock on Plate Silver | Silver | | \$572.00 | set |
| # 7948 | Wifi Bridge G2 Gateway | Wht | | \$250.00 | ea |
| # 7950-sh | Wall cavity unit 2040 x 820/770/720/620 x 90 mm (Max 65kg) | | 16 | \$424.00 | ea |
| # 7950-sh | Wall cavity unit 2040 x 870/920 x 90 mm (Max 65kg) | | 16 | \$523.00 | ea |
| # 7950-sh | Wall cavity unit 2040 x 1020 x 90 mm (Max 65kg) | | 16 | \$583.00 | ea |
| # 7950-oh | Wall cavity unit 2340 x 820/770/720/620 x 90 mm (Max 65kg) | | 16 | \$512.00 | ea |
| # 7950-oh | Wall cavity unit 2340 x 870/920 x 90 mm (Max 65kg) | | 16 | \$594.00 | ea |
| # 7950-oh | Wall cavity unit 2340 x 1020 x 90 mm (Max 65kg) | | 16 | \$638.00 | ea |
| 7960 | Lock mortice only - single door | | | \$115.00 | ea |
| 7961 | Lock mortice only - rebated doors | | | \$128.00 | ea |
| 7962 | Lock mortice & flush bolt rout - rebated doors | | | \$153.00 | ea |
| 7963 | Lock mortice & flush bolt rout - pre hung doors | | | \$185.00 | ea |
| 7964 | Lock mortice & 2 x flush pull rout - single slider | | | \$153.00 | ea |
| 7965 | Lock mortice & 4 x flush pull rout - rebated slider | | | \$217.00 | ea |
| 7966 | Mortice for tubelatch | | | \$39.00 | ea |
| 7967 | Mortice for rebated tubelatch | | | \$45.00 | ea |
| 7970 | Rout for flush pulls - door or window | | | \$39.00 | ea |
| 7971 | Rout for euro/passage flush pull set | | | \$90.00 | ea |
| 7972 | Rout for reverse barrel bolt | | | \$45.00 | ea |
| 7973 | Rout for standard window flush bolt | | | \$45.00 | ea |
| 7974 | Rout for over height window flush bolt | | | \$64.00 | ea |
| 7975 | Rout for standard door flush bolt | | | \$51.00 | ea |
| 7976 | Rout for over height door flush bolt | | | \$83.00 | ea |
| Acorn B | Kwila Post Ball - Acorn B 100 x 100 mm | T | 7 | \$35.00 | ea |
| Ball A | Kwila Post Ball - Ball A 75 x 75 mm | T | 7 | \$27.00 | ea |
| Crown 2 | Kwila Post Ball - Crown 2 100 x 100 mm | T | 7 | \$37.00 | ea |
| Crown 3 | Kwila Post Ball - Crown 3 100 x 100 mm | T | 7 | \$44.00 | ea |
| # C3-9 | Post Decorative Cap 3 90 x 90 mm | Al | 13 | \$111.00 | ea |
| # C3-10 | Post Decorative Cap 3 100 x 100 mm | Al | 13 | \$111.00 | ea |
| # C3-12 | Post Decorative Cap 3 120 x 120 mm | Al | 13 | \$129.00 | ea |
| # C3-12S | Post Decorative Cap 3 125 x 125 mm | Al | 13 | \$129.00 | ea |
| # C3-15 | Post Decorative Cap 3 150 x 150 mm | Al | 13 | \$164.00 | ea |
| # C4-9 | Post Decorative Cap 4 90 x 90 mm | Al | 13 | \$111.00 | ea |
| # C4-10 | Post Decorative Cap 4 100 x 100 mm | Al | 13 | \$111.00 | ea |
| # C4-12 | Post Decorative Cap 4 120 x 120 mm | Al | 13 | \$129.00 | ea |
| # C4-12S | Post Decorative Cap 4 125 x 125 mm | Al | 13 | \$129.00 | ea |

| Code | Description | Finish | Material | Price | Unit |
|----------|------------------------------------|--------|----------|----------|------|
| # C4-15 | Post Decorative Cap 4 150 x 150 mm | Al | 13 | \$164.00 | ea |
| # C7-9 | Post Decorative Cap 7 90 x 90 mm | Al | 13 | \$111.00 | ea |
| # C7-10 | Post Decorative Cap 7 100 x 100 mm | Al | 13 | \$111.00 | ea |
| # C7-12 | Post Decorative Cap 7 120 x 120 mm | Al | 13 | \$129.00 | ea |
| # C7-12S | Post Decorative Cap 7 125 x 125 mm | Al | 13 | \$129.00 | ea |
| # C7-15 | Post Decorative Cap 7 150 x 150 mm | Al | 13 | \$164.00 | ea |
| # C8-9 | Post Decorative Cap 8 90 x 90 mm | Al | 13 | \$111.00 | ea |
| # C8-10 | Post Decorative Cap 8 100 x 100 mm | Al | 13 | \$111.00 | ea |
| # C8-12 | Post Decorative Cap 8 120 x 120 mm | Al | 13 | \$129.00 | ea |
| # C8-12S | Post Decorative Cap 8 125 x 125 mm | Al | 13 | \$129.00 | ea |
| # C8-15 | Post Decorative Cap 8 150 x 150 mm | Al | 13 | \$164.00 | ea |
| FP7 | Finial 7 - 63 x 34 mm | T | 7 | \$12.00 | ea |
| RF2-65 | Roof Finial 2 - 70 x 70 mm; 650mm | T | 7 | \$88.00 | ea |
| RF2-76 | Roof Finial 2 - 70 x 70 mm; 760mm | T | 7 | \$92.00 | ea |
| RF2-95 | Roof Finial 2 - 70 x 70 mm; 950mm | T | 7 | \$114.00 | ea |
| RF3-65 | Roof Finial 3 - 70 x 70 mm; 650mm | T | 7 | \$88.00 | ea |
| RF3-76 | Roof Finial 3 - 70 x 70 mm; 760mm | T | 7 | \$92.00 | ea |
| RF3-95 | Roof Finial 3 - 70 x 70 mm; 950mm | T | 7 | \$114.00 | ea |
| T16 | Corbel 320 x 100 x 75 mm | T | 13 | \$78.00 | ea |



VERSION 8.24

BRISBANE
1095 Ipswich Rd
Moorooka 4105
☎ 07 3848 1383
F: 07 3892 1476

GOLD COAST
Warehouse Road
Southport 4215
☎ 07 5571 0088
F: 07 5571 0617

SUNCOAST
53 Wisers Road
Maroochydore
☎ 07 5479 0999
F: 07 5479 0911

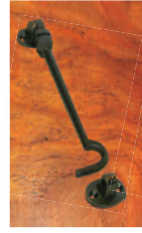

Doors and windows are the eyes and ears of a building but the handles are its handshake...

The range of door hardware available on the Australian market is so extensive that it challenges even the most experienced hardware specialist. For someone not familiar with hardware, this can often result in hardware purchases that are not suitable for the application. Woodworkers have designed a range of hardware that aesthetically enhance your doors and windows, while providing all of the security functions you require.

